







Beschlag für 2–3 unten laufende Holztüren (19/25 mm) bis 50 kg, mit aufgeschraubter Laufschiene. Design Mixslide ohne Dämpfeinzug.

Produkt-Highlights

-  **Ästhetik** Untenlaufendes System mit Abstützung des gesamten Türgewichts am Boden ermöglicht Schrankdesign mit geringen Materialstärken
-  **Komfort** Leichter, flüsterleiser Lauf mit Hawa Comfort Rolle

Technische Vorgaben

-  max. 50 kg
-  max. 2400 mm
-  max. 1400 mm
-  19/25 mm

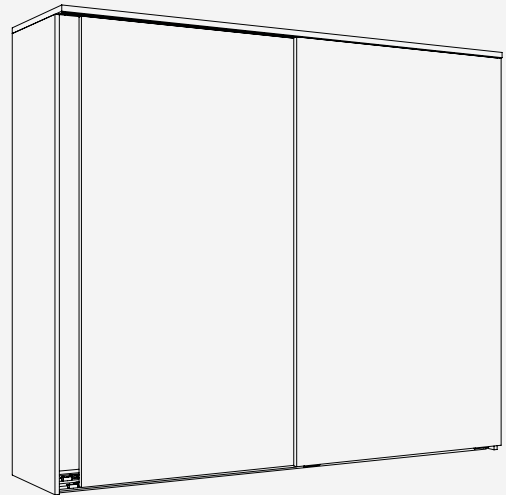

Einbaubeispiele

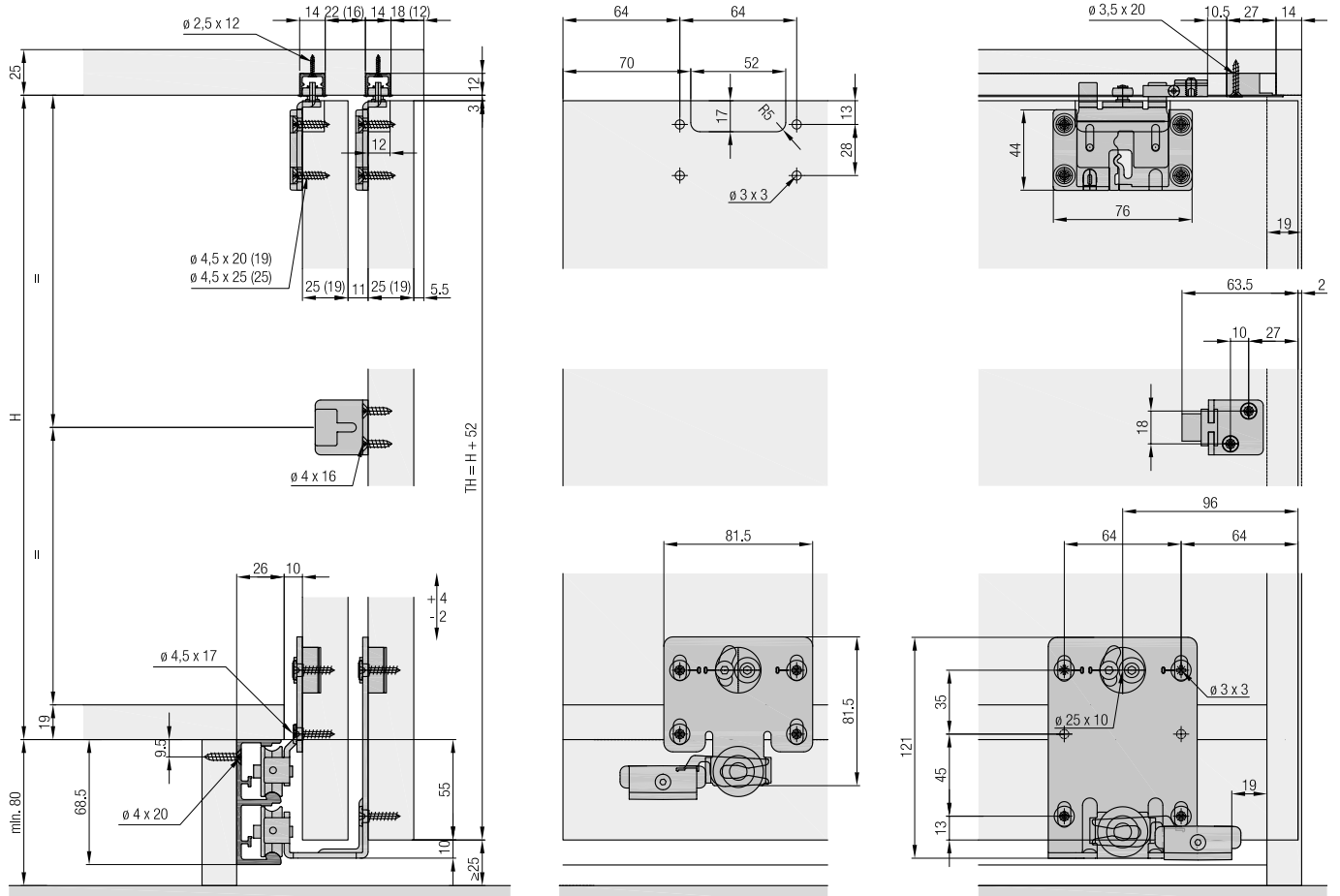

Garnitur für 2 oder 3 Holztüren, 19 mm

| | Nr. |
|--|--------------|
| Hawa Combino 50 H MS, Türstärke 19 mm, für 2 Türen | 055.3199.071 |
| Hawa Combino 50 H MS, Türstärke 19 mm, für 3 Türen | 055.3199.073 |

| Garnitur bestehend aus: | 055.3199.071 | | 055.3199.073 | | Nr. |
|---|--------------|----|--------------|--|--------------|
| | | | | | |
|  Laufwerk, Innentüre, Stahl, verzinkt | 2 | 4 | | | 055.3169.071 |
|  Laufwerk, Aussentüre, 19 mm, Stahl, verzinkt | 2 | 2 | | | 055.3113.175 |
|  Führungswinkel, Stahl, verzinkt | 4 | 6 | | | 055.3059.171 |
|  Gehäuse Führungswinkel, Kunststoff, anthrazit | 4 | 6 | | | 055.0282.001 |
|  Aushängesicherung, Kunststoff, rot | 4 | 6 | | | 055.0186.001 |
|  Stopper, Kunststoff, grau | 4 | 4 | | | 055.3167.071 |
|  Rückhaltefeder zu Stopper, Kunststoff, grau | 2 | 3 | | | 055.0204.001 |
|  Stopper Führung, Kunststoff, grau | 4 | 4 | | | 040.3079.074 |
|  Türmitnehmer, bei 2 Türen, Stahl, verzinkt | 1 | | | | 055.3124.071 |
|  Schienenendstück, Kunststoff, grau, 31 mm | 3 | 4 | | | 040.3083.002 |
|  Schienenendstück, Kunststoff, grau, 22 mm | 1 | | | | 040.3083.003 |
|  Kombi-Schraube, 4,5x17 mm, Stahl, verzinkt | 16 | 24 | | | 055.0100.101 |
|  Senkkopfschraube, 4,5x20 mm, Stahl, verzinkt | 16 | 24 | | | 600.0000.167 |
|  Senkkopfschraube, 3,5x20 mm, Stahl, verzinkt | 4 | 4 | | | 766.5035.120 |
|  Türmitnehmer, bei 3 Türen, Set à 2 Stück, Stahl, verzinkt | | | 1 | | 056.3095.171 |
|  Puffer, mit Kleber, Set à 2 Stück | | | 1 | | 053.3364.051 |

Garnitur für 2 oder 3 Holztüren, 25 mm

| | Nr. |
|--|--------------|
| Hawa Combino 50 H MS, Türstärke 25 mm, für 2 Türen | 055.3199.072 |
| Hawa Combino 50 H MS, Türstärke 25 mm, für 3 Türen | 055.3199.074 |

| Garnitur bestehend aus: | 055.3199.072 | | 055.3199.074 | | Nr. |
|---|--------------|----|--------------|--|--------------|
| | | | | | |
|  Laufwerk, Innentüre, Stahl, verzinkt | 2 | 4 | | | 055.3169.071 |
|  Laufwerk, Aussentüre, 25 mm, Stahl, verzinkt | 2 | 2 | | | 055.3114.175 |
|  Führungswinkel, Stahl, verzinkt | 4 | 6 | | | 055.3059.171 |
|  Gehäuse Führungswinkel, Kunststoff, anthrazit | 4 | 6 | | | 055.0282.001 |
|  Aushängesicherung, Kunststoff, rot | 4 | 6 | | | 055.0186.001 |
|  Stopper, Kunststoff, grau | 4 | 4 | | | 055.3167.071 |
|  Rückhaltefeder zu Stopper, Kunststoff, grau | 2 | 3 | | | 055.0204.001 |
|  Stopper Führung, Kunststoff, grau | 4 | 4 | | | 040.3079.074 |
|  Türmitnehmer, bei 2 Türen, Stahl, verzinkt | 1 | | | | 055.3124.071 |
|  Schienenendstück, Kunststoff, grau, 31 mm | 3 | 4 | | | 040.3083.002 |
|  Schienenendstück, Kunststoff, grau, 22 mm | 1 | | | | 040.3083.003 |
|  Kombi-Schraube, 4,5x17 mm, Stahl, verzinkt | 16 | 24 | | | 055.0100.101 |
|  Senkkopfschraube, 4,5x25 mm, Stahl, verzinkt | 16 | 24 | | | 766.5045.125 |
|  Senkkopfschraube, 3,5x20 mm, Stahl, verzinkt | 4 | 4 | | | 766.5035.120 |
|  Türmitnehmer, bei 3 Türen, Set à 2 Stück, Stahl, verzinkt | | | 1 | | 056.3095.171 |
|  Puffer, mit Kleber, Set à 2 Stück | | | 1 | | 053.3364.051 |

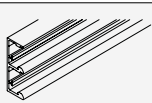

Laufschienen

| | | mm | Nr. |
|---|---|------|--------------|
|  | Doppellaufschiene, Aluminium, eloxiert, gelocht | 2500 | 055.3161.250 |
| | | 3500 | 055.3161.350 |
| | | 6000 | 055.3161.600 |

Führungsschienen

| | | mm | Nr. |
|---|--|------|--------------|
|  | Führungsschiene, Aluminium, gelocht | 2500 | 056.3079.250 |
| | | 3500 | 056.3079.350 |
| | | 6000 | 056.3079.600 |

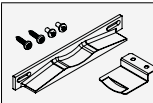
Zubehör

| | | Nr. |
|---|---|--------------|
|  | Zwischenstopper-Set, für 3 Türen | 055.3218.071 |
|  | Bohr- und Fräslehre, für Bearbeitung Führungswinkel, Holz | 055.3099.001 |

Berechnungen

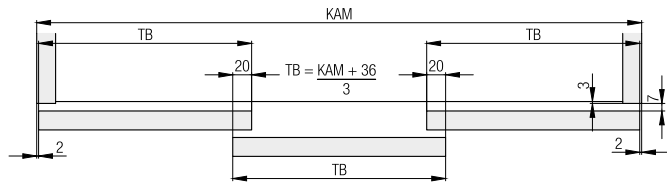
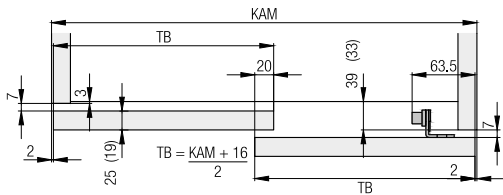

Schienenendstück

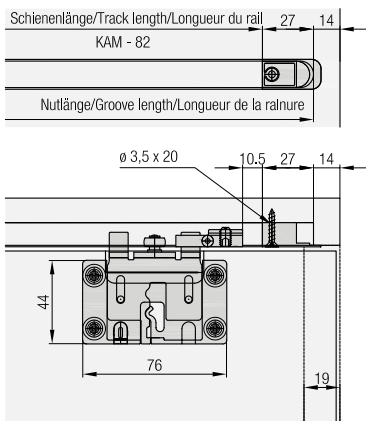

Zwischenstopper bei 3 Türen

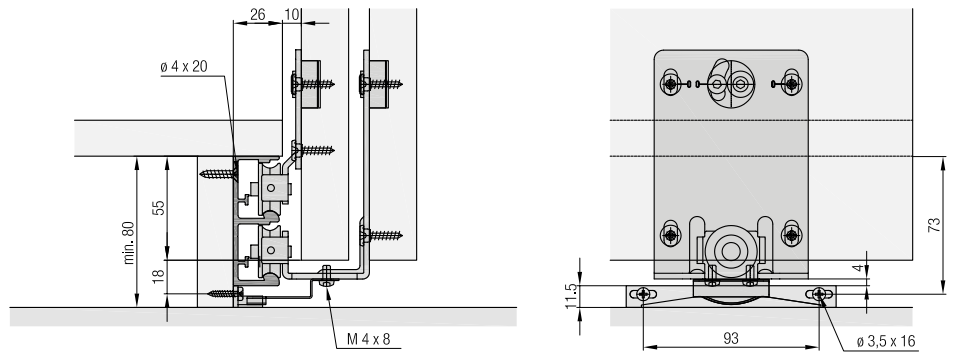

Griffprofile

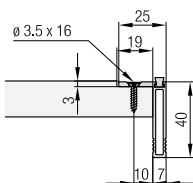

Zubehör

- Ausrichtbeschlag ab Seite 315
- Griffprofile ab Seite 318

Planung/Ausführung

Weitere Informationen zum Produkt finden Sie auf www.hawa.com.