







**Beschlag für 1–3 unten laufende Holztüren bis 40 kg in L-Form. Dämpfungszug optional. Design Forslide.**

**Produkt-Highlights**

-  **Komfort** Hoher Bedienungskomfort dank bewährter Lauftechnik und im System integrierter Dämpfungstechnologie
-  **Ästhetik** Türen in L-Form für einzigartiges Schrankdesign mit zweiseitigem Zugriff auf den Schrankinhalt

**Technische Vorgaben**

-  max. 40 kg
-  max. 1500 mm
-  max. 1500 mm
-  19 mm

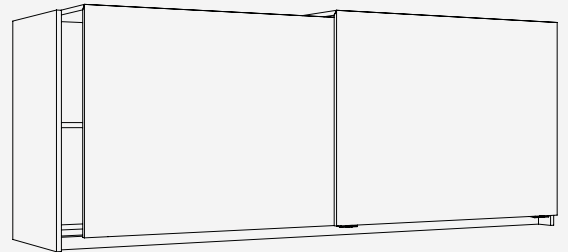



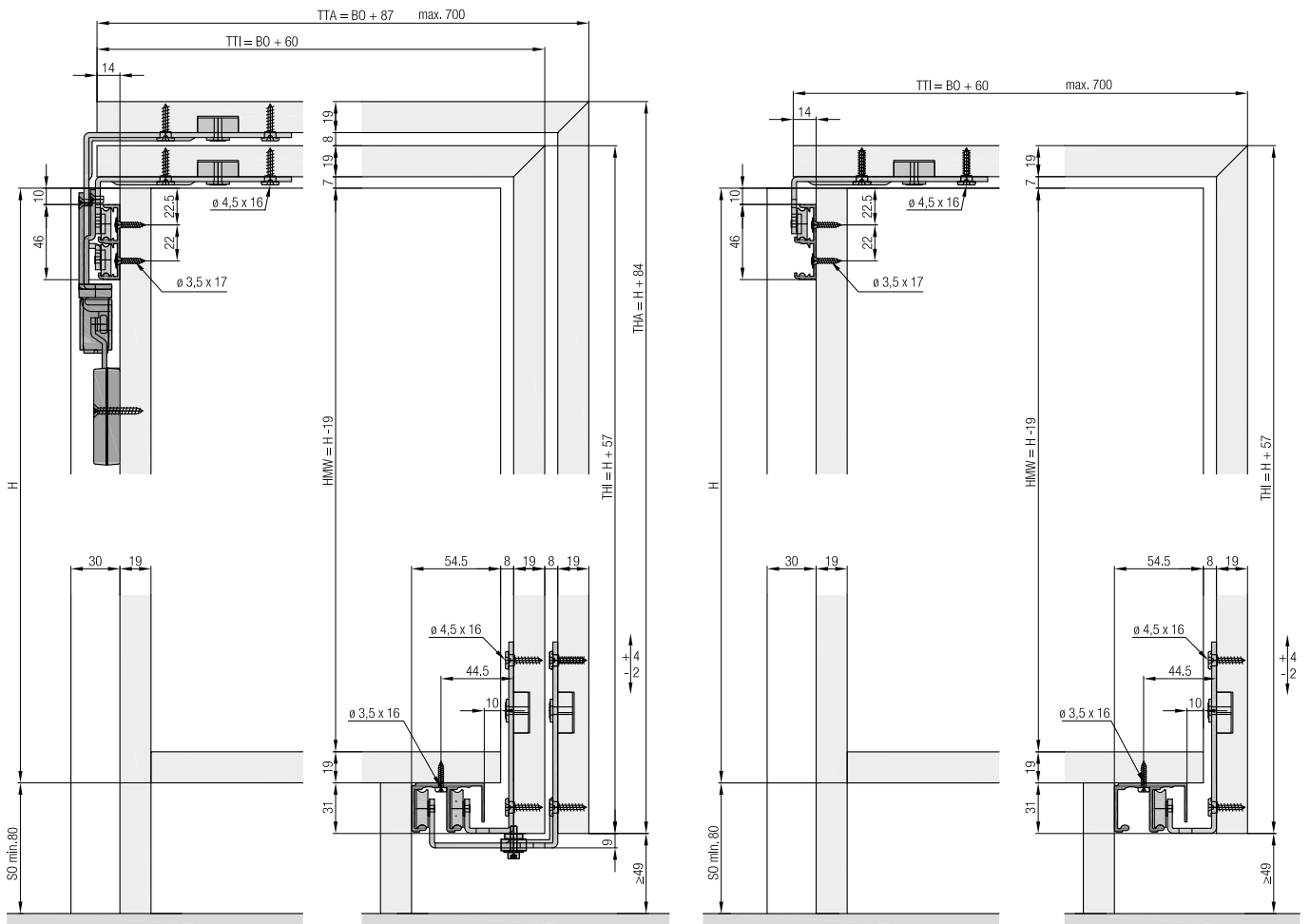





**Einbaubeispiele**

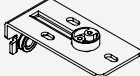

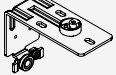

**Garnitur für 1 bis 3 Holztüren**

	Nr.
Hawa Combino L 40 H FS, für 1 Holztüre	056.3160.071
Hawa Combino L 40 H FS, für 2 Holztüren	056.3160.072
Hawa Combino L 40 H FS, für 3 Holztüren	056.3160.073

Garnitur bestehend aus:	056.3160.071	056.3160.072	056.3160.073	Nr.
	 Laufwerk, Innentüre, Stahl, verzinkt	2	2	
 Führungswinkel, Innentüre, Stahl, verzinkt	2	2	4	056.3157.171
 Stopper, Kunststoff, grau	2	4	4	056.3151.071
 Arretierfeder, Stahl	2	2	3	056.0174.001
 Stopper, Stahl, verzinkt	2	4	4	056.3150.171
 Kombi-Schraube, 4.5x17 mm, Stahl, verzinkt	12	24	36	055.0100.101
 Holzschraube 3.5x17 mm, Stahl, verzinkt	16	16	16	766.6052.100
 Laufwerk, Aussentüre, Stahl, verzinkt		2	2	056.3154.171
 Führungswinkel, Aussentüre, Stahl, verzinkt		2	2	056.3156.171
 Türmitnehmer, bei 2-3 Türen		1	2	056.3162.171
 Gummipuffer, Kunststoff, grau			3	025.0107.001

**Laufschienen**

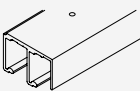



	mm	Nr.
	2500	056.3149.250
	3500	056.3149.350
	6000	056.3149.600

**Führungsschienen**

	mm	Nr.
	2500	056.3148.250
	3500	056.3148.350
	6000	056.3148.600

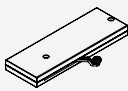



**Dämpfeinzug (nur für System mit 2 Türen)**

	Nr.
Dämpfeinzug, 18–40 kg, mit Mitnehmer schmal, 2 Stück	055.3091.074

Garnitur bestehend aus:		055.3091.074	Nr.
	Dämpfeinzug, links, 18–40 kg	1	
	Dämpfeinzug, rechts, 18–40 kg	1	055.3090.074
	Mitnehmer, für Dämpfeinzug, rechts, Kunststoff, grau	1	055.3041.071
	Mitnehmer, für Dämpfeinzug, links, Kunststoff, grau	1	055.3041.072
	Rundkopfschraube, 4x16 mm, Stahl, verzinkt	4	600.0000.166
	Senkkopfschraube, 4x30 mm, Stahl, verzinkt	4	600.0000.439

**Adapter Dämpfeinzug**

	Nr.
Adapter-Set, für Dämpfeinzug	056.3164.071

Garnitur bestehend aus:		056.3164.071	Nr.
	Adapter, für Dämpfeinzug, Aussentüre, oben, Stahl verzinkt	1	
	Adapter, für Dämpfungssystem, Innentüre, oben, Stahl, verzinkt	1	056.0179.102
	Linsenkopfschraube, M4x8 mm, Stahl, verzinkt	4	759.0408.108
	Gewindeschneidende Senkschraube, M4x8 mm, Stahl, verzinkt	4	600.0000.344

**Berechnung**

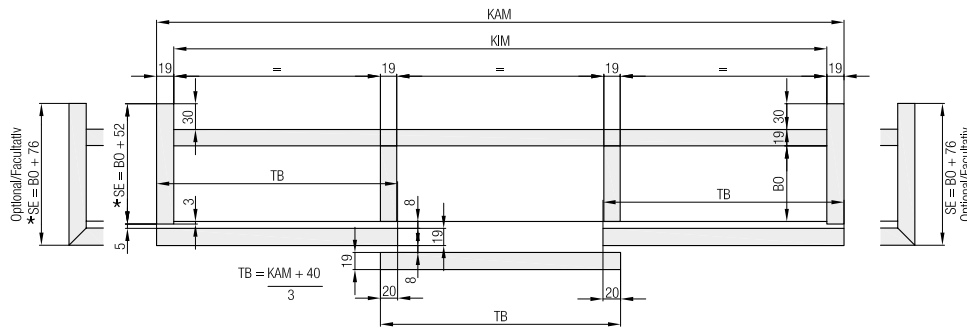

\* Seite demontierbar für Türmontage  
Removable side for door mounting  
Côte démontable pour montage de porte

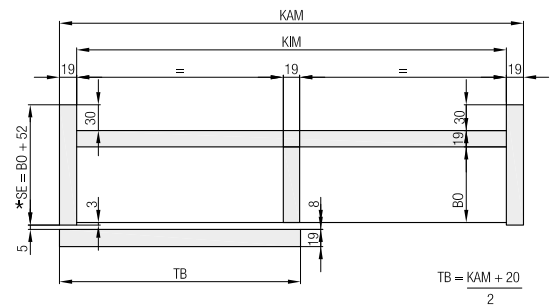
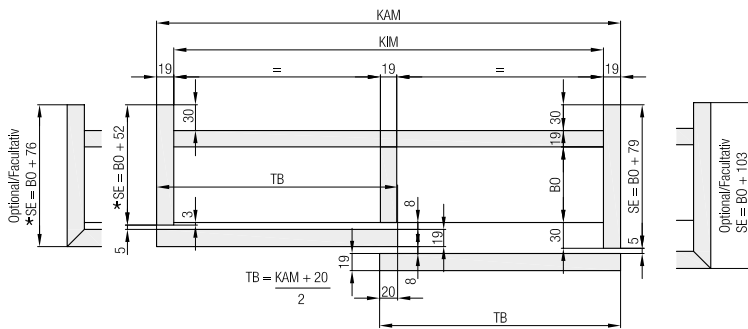

**Dämpfeinzug**

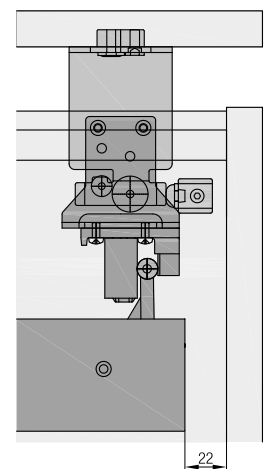
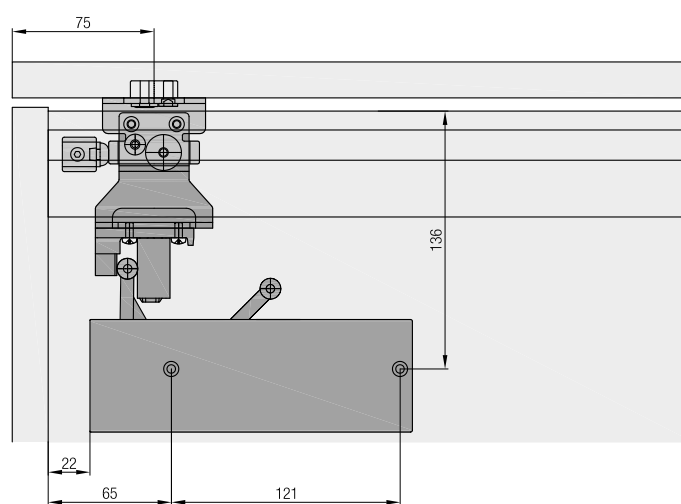
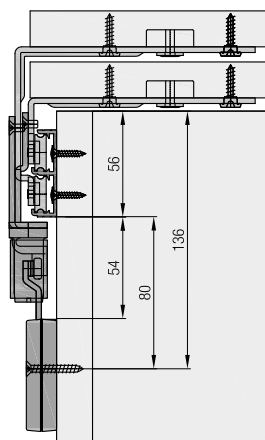

**Zubehör**

- Ausrichtbeschlag ab Seite 315
- Bestellübersicht Dämpfeinzüge ab Seite 320

**Planung/Ausführung**

Weitere Informationen zum Produkt finden Sie auf [www.hawa.com](http://www.hawa.com).