







Beschlag für 2 oder 4 synchron laufende Holztüren bis 40 kg in L-Form. Design Forslide.

Produkt-Highlights

-  **Komfort** Hoher Bedienungskomfort dank bewährter Lauftechnik und im System integrierter Dämpfungstechnologie
-  **Ästhetik** Synchron laufende Türen in L-Form für einzigartiges Schrankdesign mit zweiseitigem Zugriff auf den Schrankinhalt

Technische Vorgaben

-  max. 40 kg
-  max. 1500 mm
-  max. 800 mm
-  19 mm

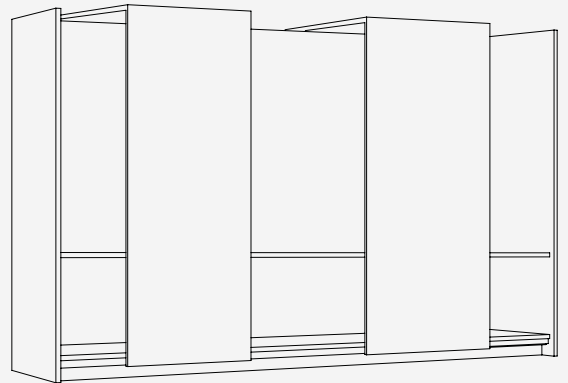

Einbaubeispiele

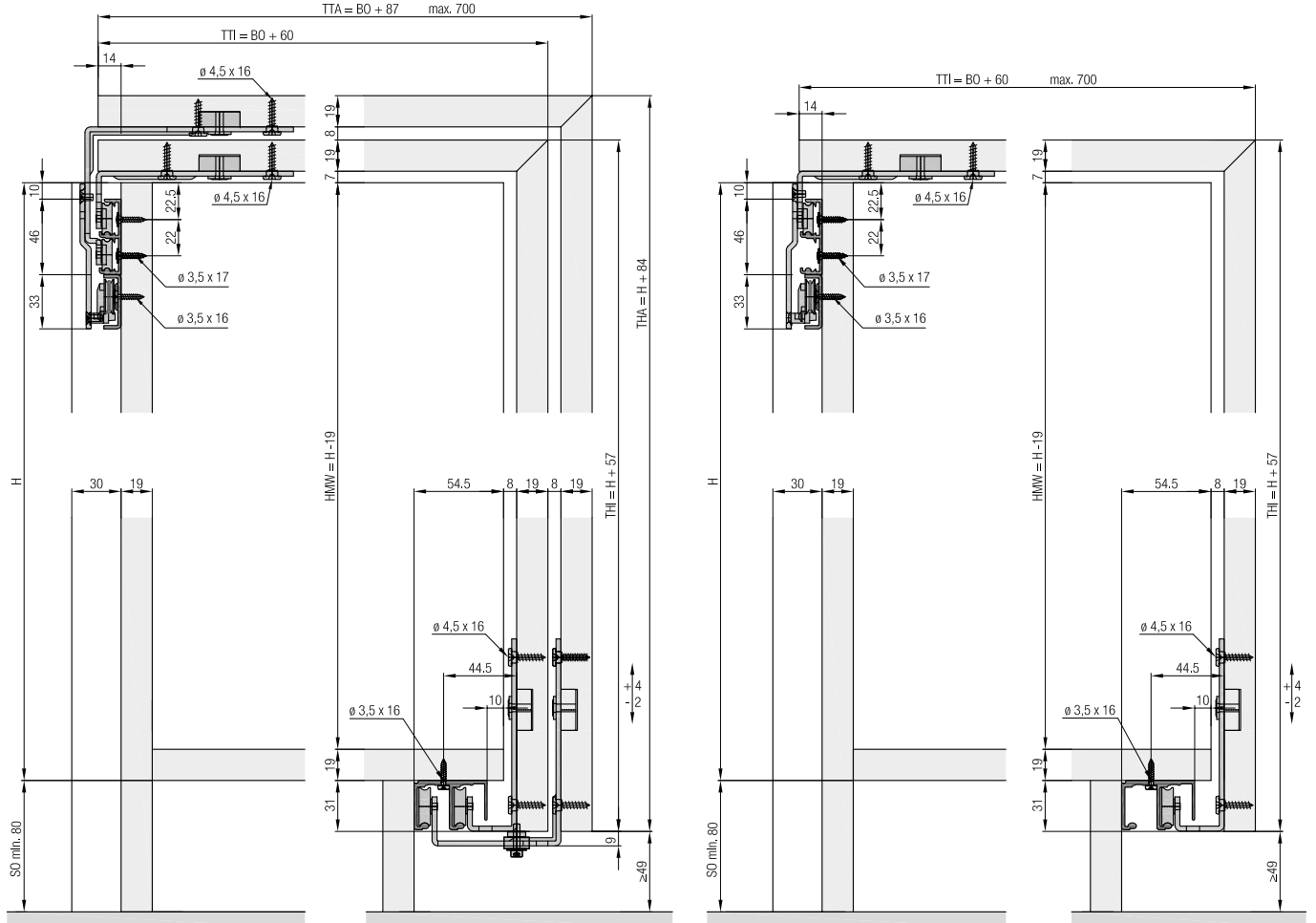

Von oben/2 Holztüren

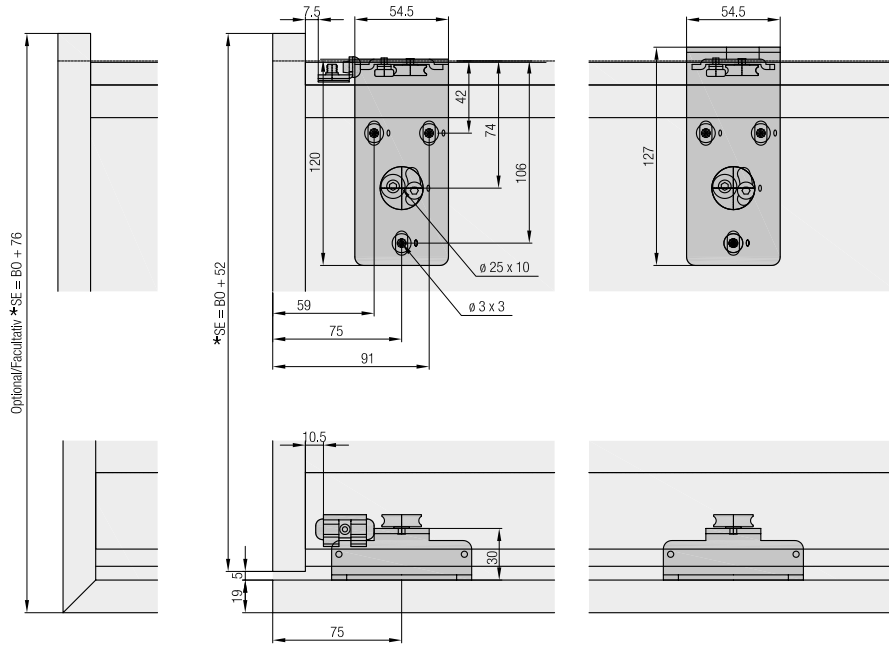

Von vorne/2 Holztüren

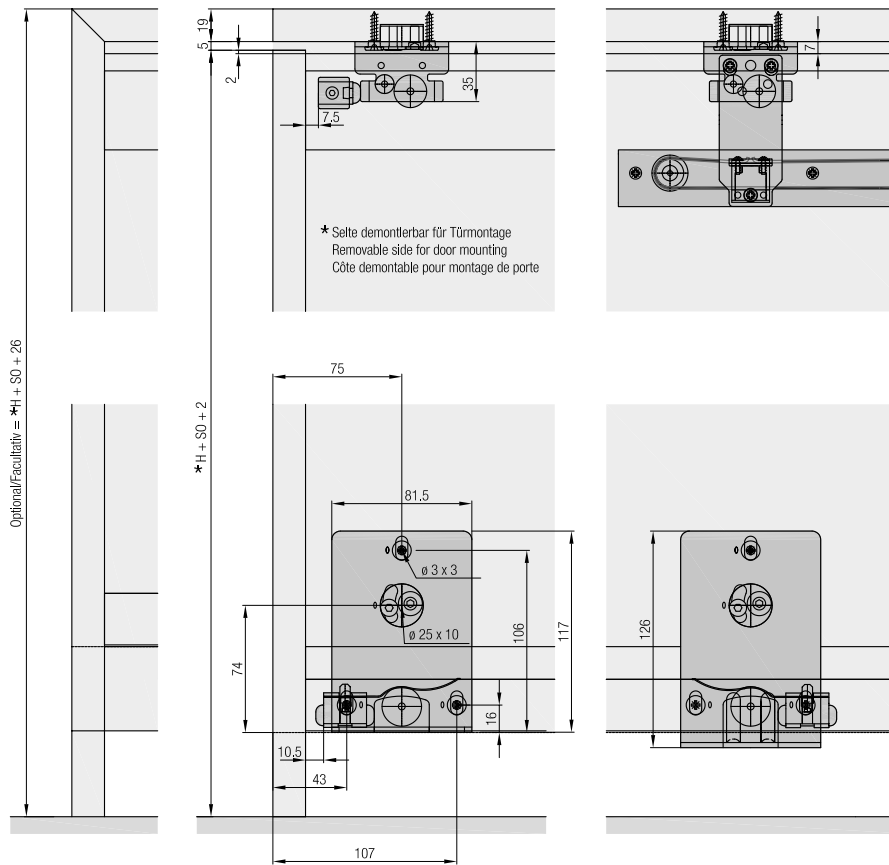

Von oben/4 Holztüren

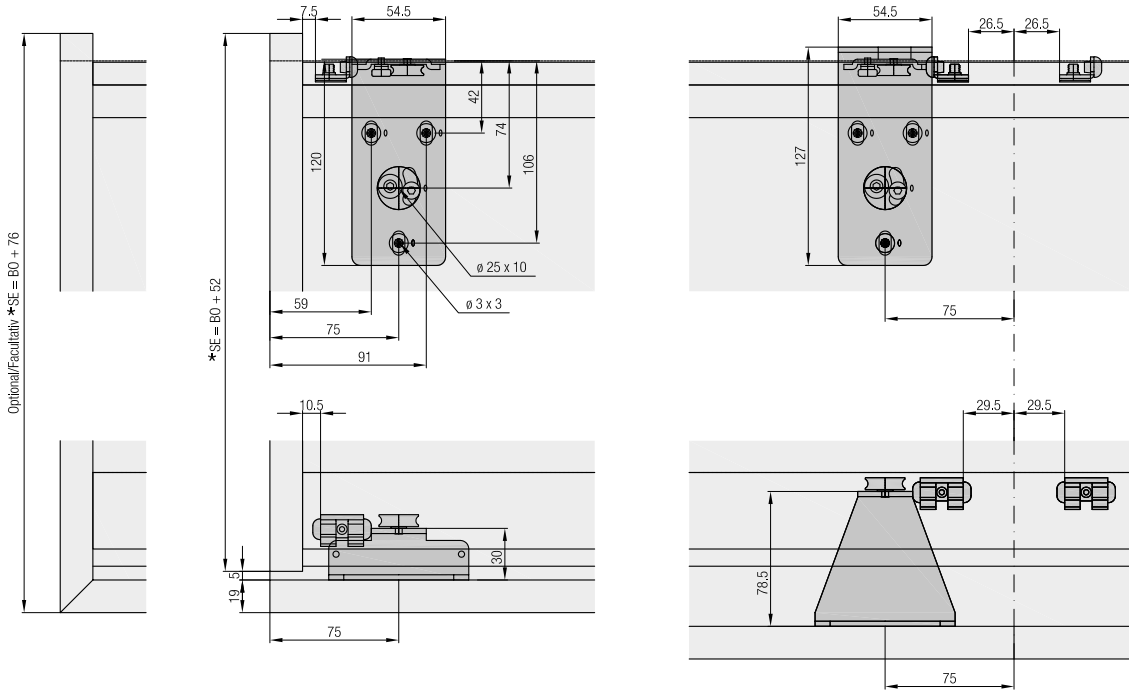

Von vorne/4 Holztüren

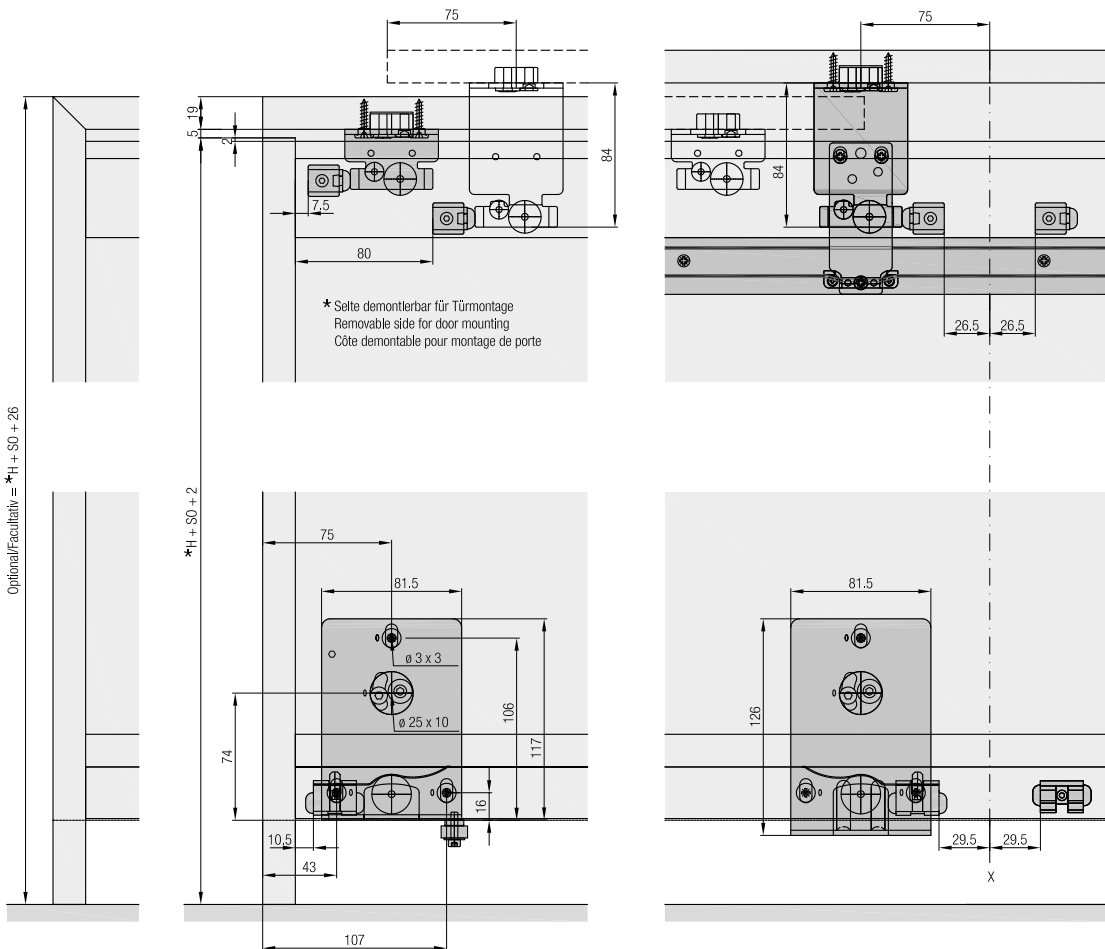





**Garnitur für 1 oder 2 Holztüren
Immer 2 Garnituren bestellen.**

	Nr.
Hawa Combino L 40 H FS, für 1 Holztüre	056.3160.071
Hawa Combino L 40 H FS, für 2 Holztüren	056.3160.072

Garnitur bestehend aus:	056.3160.071		056.3160.072		Nr.
 Laufwerk, Innentüre, Stahl, verzinkt	2	2			056.3155.171
 Führungswinkel, Innentüre, Stahl, verzinkt	2	2			056.3157.171
 Stopper, Kunststoff, grau	2	4			056.3151.071
 Arretierfeder, Stahl	2	2			056.0174.001
 Stopper, Stahl, verzinkt	2	4			056.3150.171
 Kombi-Schraube, 4.5x17 mm, Stahl, verzinkt	12	24			055.0100.101
 Holzschraube, 3.5x17 mm, Stahl, verzinkt	16	16			766.6052.100
 Laufwerk, Aussentüre, Stahl, verzinkt			2		056.3154.171
 Führungswinkel, Aussentüre, Stahl, verzinkt			2		056.3156.171
 Türmitnehmer, bei 2-3 Türen			1		056.3162.171

Garnitur Synchro

	Nr.
Hawa Combino L 40 H FS Synchro	056.3173.071

Garnitur bestehend aus:	056.3173.071		Nr.
 Symmetric-Schiene, Aluminium	1		040.5044.171
 Adapter, für Symmetric-Schiene, Stahl, verzinkt	2		056.0189.101
 Rundkopf Spannplattenschraube 3.5x16 mm, Stahl, verzinkt	8		766.6035.116
 Gewindeschneidende Senkkopfschraube, M4x8 mm, Stahl, verzinkt	4		762.7007.108
 Senkkopfschraube, M4x10 mm, Stahl, verzinkt	2		762.5003.100

Laufschienen

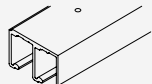
	mm		Nr.
 Doppellaufschiene, Aluminium, eloxiert, gelocht	2500		056.3149.250
	3500		056.3149.350
	6000		056.3149.600

Führungsschienen

	mm		Nr.
 Doppelführungsschiene, Aluminium, eloxiert, gelocht	2500		056.3148.250
	3500		056.3148.350
	6000		056.3148.600

Berechnungen

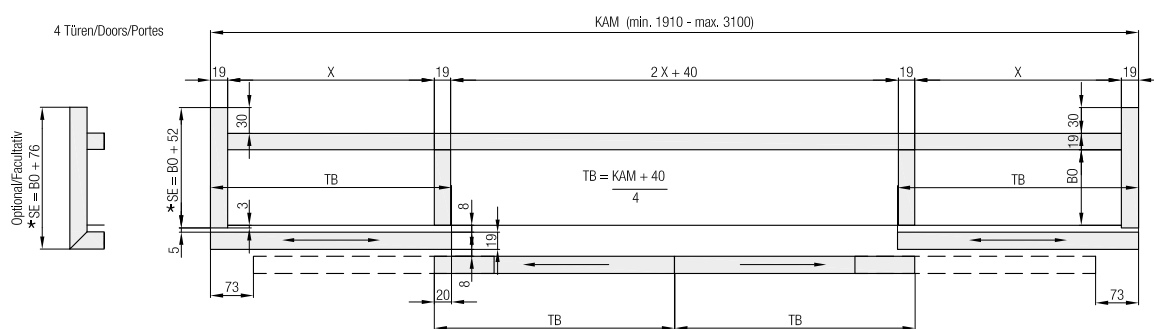
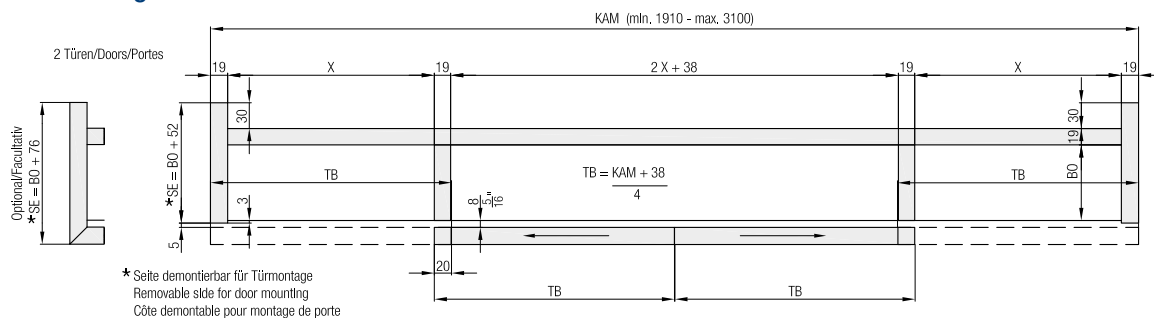

Zubehör

- Ausrichtbeschlag ab Seite 257
- Bestellübersicht Dämpfeinzüge ab Seite 262

Planung/Ausführung

Weitere Informationen zum Produkt finden Sie auf www.hawa.com.