

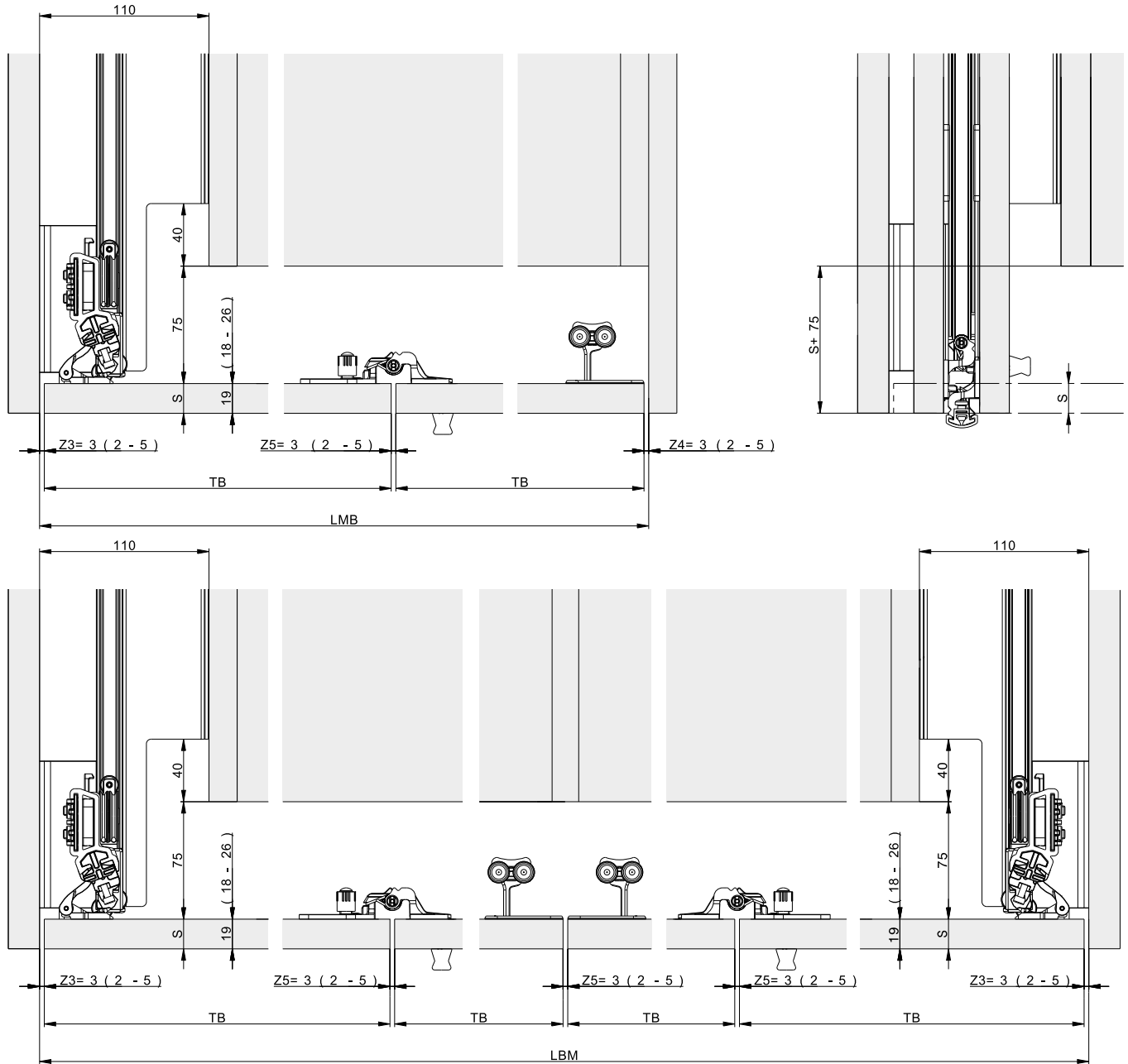

Türe aufschlagend ohne Bodenprofil, 2- und 4-türig



## Benötigte Komponenten

### für 2-türige Schränke

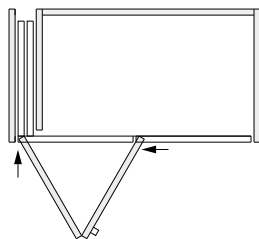

#### Hawa Folding Concepta III 20 Pull, links Aluminium, eloxiert

	Nr.
Hawa Folding Concepta III 20 Pull, Grundgarnitur, Türhöhe 1200–2200 mm	31506
Hawa Folding Concepta III 20/25 Pull, Einschiebegarnitur, links	31512
Hawa Folding Concepta III 20/25, Schienen-Set 2-türig, links, Aluminium, eloxiert	31514
Hawa Folding Concepta III 20, Holm-Set, Türhöhe 1200–2200 mm, Aluminium, eloxiert	31519

#### Aluminium, schwarz eloxiert

	Nr.
Hawa Folding Concepta III 20 Pull, Grundgarnitur, Türhöhe 1200–2200 mm	31506
Hawa Folding Concepta III 20/25 Pull, Einschiebegarnitur, links	31512
Hawa Folding Concepta III 20/25, Schienen-Set 2-türig, links, Aluminium, schwarz eloxiert	31521
Hawa Folding Concepta III 20, Holm-Set, Türhöhe 1200–2200 mm, Aluminium, schwarz eloxiert	31526

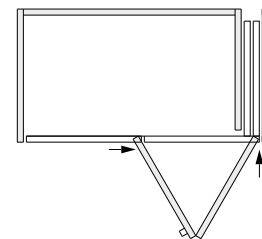

#### Hawa Folding Concepta III 20 Pull, rechts Aluminium, eloxiert

	Nr.
Hawa Folding Concepta III 20 Pull, Grundgarnitur, Türhöhe 1200–2200 mm	31506
Hawa Folding Concepta III 20/25 Pull, Einschiebegarnitur, rechts	31513
Hawa Folding Concepta III 20/25, Schienen-Set 2-türig, rechts, Aluminium, eloxiert	31515
Hawa Folding Concepta III 20, Holm-Set, Türhöhe 1200–2200 mm, Aluminium, eloxiert	31519

#### Aluminium, schwarz eloxiert

	Nr.
Hawa Folding Concepta III 20 Pull, Grundgarnitur, Türhöhe 1200–2200 mm	31506
Hawa Folding Concepta III 20/25 Pull, Einschiebegarnitur, rechts	31513
Hawa Folding Concepta III 20/25, Schienen-Set 2-türig, rechts, Aluminium, schwarz eloxiert	31522
Hawa Folding Concepta III 20, Holm-Set, Türhöhe 1200–2200 mm, Aluminium, schwarz eloxiert	31526

### für 4-türige Schränke

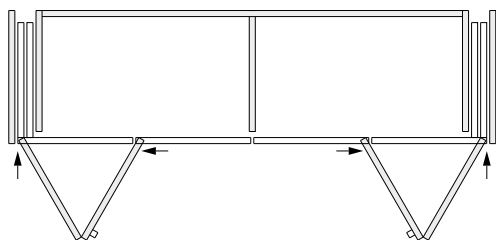

#### Hawa Folding Concepta III 20 Pull, links/rechts Aluminium, eloxiert

	Stk.	Nr.
Hawa Folding Concepta III 20 Pull, Grundgarnitur, Türhöhe 1200–2200 mm	2	31506
Hawa Folding Concepta III 20/25 Pull, Einschiebegarnitur, links	1	31512
Hawa Folding Concepta III 20/25 Pull, Einschiebegarnitur, rechts	1	31513
Hawa Folding Concepta III 20/25, Schienen-Set 4-türig, Aluminium, eloxiert	1	31518
Hawa Folding Concepta III 20, Holm-Set, Türhöhe 1200–2200 mm, Aluminium, eloxiert	2	31519

#### Aluminium, schwarz eloxiert

	Stk.	Nr.
Hawa Folding Concepta III 20 Pull, Grundgarnitur, Türhöhe 1200–2200 mm	2	31506
Hawa Folding Concepta III 20/25 Pull, Einschiebegarnitur, links	1	31512
Hawa Folding Concepta III 20/25 Pull, Einschiebegarnitur, rechts	1	31513
Hawa Folding Concepta III 20/25, Schienen-Set 4-türig, Aluminium, schwarz eloxiert	1	31525
Hawa Folding Concepta III 20, Holm-Set, Türhöhe 1200–2200 mm, Aluminium, schwarz eloxiert	2	31526

für 3-türige Schränke

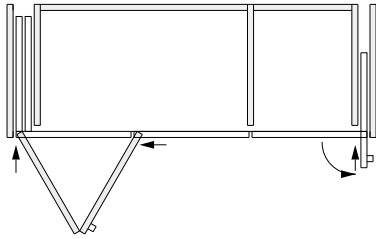

Hawa Folding Concepta III 20 Pull, links mit  
Hawa Concepta III 25 Pull, rechts

Aluminium, eloxiert

	Nr.
Hawa Folding Concepta III 20 Pull, Grundgarnitur, Türhöhe 1200–2200 mm	31506
Hawa Folding Concepta III 20/25 Pull, Einschriebegarnitur, links	31512
Hawa Folding Concepta III 20/25, Schienen-Set 3-türig, links, Aluminium, eloxiert	31516
Hawa Folding Concepta III 20, Holm-Set, Türhöhe 1200–2200 mm, Aluminium, eloxiert	31519
Hawa Concepta III 25 Push/Pull, Grundgarnitur rechts, Türhöhe 1200–2200 mm	30995
Hawa Concepta III 25/35 Pull, Einschriebegarnitur, rechts	31001
Holmprofil, für Türhöhe 1200–2200 mm, Aluminium, eloxiert, L= 1974 mm	30778
Connector-Set 55 mm, für Verbindung Aussenseite mit Korpus	31005

Aluminium, schwarz eloxiert

	Nr.
Hawa Folding Concepta III 20 Pull, Grundgarnitur, Türhöhe 1200–2200 mm	31506
Hawa Folding Concepta III 20/25 Pull, Einschriebegarnitur, links	31512
Hawa Folding Concepta III 20/25, Schienen-Set 3-türig, links, Aluminium, schwarz eloxiert	31523
Hawa Folding Concepta III 20, Holm-Set, Türhöhe 1200–2200 mm, Aluminium, schwarz eloxiert	31526
Hawa Concepta III 25 Push/Pull, Grundgarnitur rechts, Türhöhe 1200–2200 mm	30995
Hawa Concepta III 25/35 Pull, Einschriebegarnitur, rechts	31001
Holmprofil, für Türhöhe 1200–2200 mm, Aluminium, eloxiert, L= 1974 mm	30778
Connector-Set 55 mm, für Verbindung Aussenseite mit Korpus	31005

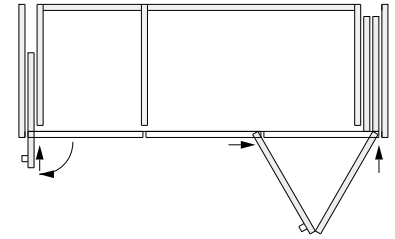

Hawa Folding Concepta III 20 Pull, rechts mit  
Hawa Concepta III 25 Pull, links

Aluminium, eloxiert

	Nr.
Hawa Folding Concepta III 20 Pull, Grundgarnitur, Türhöhe 1200–2200 mm	31506
Hawa Folding Concepta III 20/25 Pull, Einschriebegarnitur, rechts	31513
Hawa Folding Concepta III 20/25, Schienen-Set 3-türig, rechts, Aluminium, eloxiert	31517
Hawa Folding Concepta III 20, Holm-Set, Türhöhe 1200–2200 mm, Aluminium, eloxiert	31519
Hawa Concepta III 25 Push/Pull, Grundgarnitur links, Türhöhe 1200–2200 mm	30994
Hawa Concepta III 25/35 Pull, Einschriebegarnitur, links	31000
Holmprofil, für Türhöhe 1200–2200 mm, Aluminium, eloxiert, L= 1974 mm	30778
Connector-Set 55 mm, für Verbindung Aussenseite mit Korpus	31005

Aluminium, schwarz eloxiert

	Nr.
Hawa Folding Concepta III 20 Pull, Grundgarnitur, Türhöhe 1200–2200 mm	31506
Hawa Folding Concepta III 20/25 Pull, Einschriebegarnitur, rechts	31513
Hawa Folding Concepta III 20/25, Schienen-Set 3-türig, rechts, Aluminium, schwarz eloxiert	31524
Hawa Folding Concepta III 20, Holm-Set, Türhöhe 1200–2200 mm, Aluminium, schwarz eloxiert	31526
Hawa Concepta III 25 Push/Pull, Grundgarnitur links, Türhöhe 1200–2200 mm	30994
Hawa Concepta III 25/35 Pull, Einschriebegarnitur, links	31000
Holmprofil, für Türhöhe 1200–2200 mm, Aluminium, eloxiert, L= 1974 mm	30778
Connector-Set 55 mm, für Verbindung Aussenseite mit Korpus	31005



Hawa Konfigurator

## Auflistung der Einzelteile, welche in den Garnituren enthalten sind

### Garnitur für 1 falt-Einschiebetüre bis 20 kg



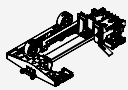

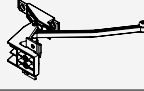
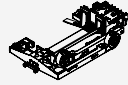

		Nr.	
Hawa Folding Concepta III 20 Pull, Grundgarnitur, Türhöhe 1200–2200 mm		31506	
		31506	Nr.
<b>Garnitur bestehend aus:</b>			
	Nutensteine für Scharnierbefestigung, Kunststoff, schwarz	3	30686
	Scharnieraufnahme mit Höheneinstellung, Stahl, vernickelt	1	30738
	Topfscharnier, mit Dämpfung und Schließfeder, Stahl, vernickelt	3	31070
	Mitteltopfscharnier, ungefedert, Stahl, matt vernickelt	3	31362
	Schraube für Topf- und Mitteltopfscharniere, 4x16 mm, Set à 20 Stück	1	31532
	Falllaufwerk, vernickelt	1	31313
	Falllaufwerkscharnier	1	31314
	Dämpfeinzug	1	31222
	Anschlagpuffer verstellbar, Kunststoff, anthrazit	1	31550
	Justierwerkzeug-Set	1	31047
	Senkkopfschraube, 4,5x16 mm, Stahl, verzinkt, Set à 28 Stück	1	31529
	Schrauben-Set für Doppellaufschiene und Connectorfixierung unten	1	31530

### Dazu passende Einschiebegarnitur

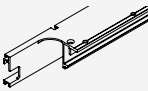
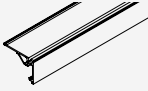
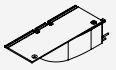
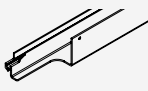
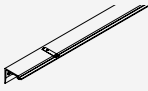
		Nr.		
Hawa Folding Concepta III 20/25 Pull, Einschiebegarnitur, links		31512		
Hawa Folding Concepta III 20/25 Pull, Einschiebegarnitur, rechts		31513		
		31512	31513	
<b>Garnitur bestehend aus:</b>				
	Einschiebeeinheit Hawa Folding Concepta III 20/25 Pull, links	1	31004	
	Endanschlagwinkel Pull, Stahl, verzinkt	1	1	31541
	Einschiebesicherung, Kunststoff, schwarz	1	1	30966
	Einschiebeeinheit Hawa Folding Concepta III 20/25 Pull, rechts		1	31046

**Dazu passende Schienen-Sets 2- und 4-türig, Aluminium, eloxiert**

	Nr.
Hawa Folding Concepta III 20/25, Schienen-Set 2-türig, links, Aluminium, eloxiert	31514
Hawa Folding Concepta III 20/25, Schienen-Set 2-türig, rechts, Aluminium, eloxiert	31515
Hawa Folding Concepta III 20/25, Schienen-Set 4-türig, Aluminium, eloxiert	31518

Garnitur bestehend aus:		31514	31515	31518	Nr.
	Doppellaufschiene oben links, Aluminium, eloxiert, L= 820 mm	1		1	31339
	Laufschiene vorne, Aluminium, eloxiert, L= 1272 mm	1	1		31210
	Laufschienenbogen, links, Aluminium, eloxiert	1		1	31365
	Führungsschiene unten links, Aluminium, eloxiert, L= 820 mm	1		1	31336
	Connector, oben links, L= 788 mm	1		1	31370
	Verbindungsprofil Connector, oben, Aluminium, L= 660 mm	1	1	2	30977
	Connector-Clips, unten, Kunststoff, schwarz, L= 94 mm	3	3	6	31086
	Verbindungsstück für Laufschienenbogen, Stahl, verzinkt	1	1	2	31543
	Abstützung Doppellaufschiene, Kunststoff, schwarz	1	1	2	31359
	Laufschienenadapter, Kunststoff, anthrazit, Set à 4 Stück	1	1	2	23645
	Senkkopfschraube für Laufschienenadapter, 4.5x16 mm, Set à 16 Stück	1	1	2	31585



Fortsetzung Tabelle auf nächster Spalte

Fortsetzung Tabelle von vorheriger Spalte

	Doppellaufschiene oben rechts, Aluminium, eloxiert, L= 820 mm		1	1	31340
	Laufschienenbogen, rechts, Aluminium, eloxiert		1	1	31366
	Führungsschiene unten rechts, Aluminium, eloxiert, L= 820 mm		1	1	31337
	Connector, oben rechts, L= 788 mm		1	1	31371
	Laufschiene vorne, Aluminium, eloxiert, L= 2539 mm			1	31343

**Holm-Set, Aluminium, eloxiert**





	Nr.
Hawa Folding Concepta III 20, Holm-Set, Türhöhe 1200–2200 mm, Aluminium, eloxiert	31519

Garnitur bestehend aus:		31519	Nr.
	Holmprofil, für Türhöhe 1200–2200 mm, Aluminium, eloxiert, L= 1974 mm	1	30778
	Abdeckblende für Türfuge, für Türhöhe 1200–2200 mm, Aluminium, eloxiert, L= 2200 mm	1	31230
	Halteclip für Abdeckblende 2200 mm, Kunststoff, schwarz, Set à 6 Stück	1	31502

**Dazu passende Schienen-Sets 3-türig,  
Aluminium, eloxiert**





	Nr.
Hawa Folding Concepta III 20/25, Schienen-Set 3-türig, links, Aluminium, eloxiert	31516
Hawa Folding Concepta III 20/25, Schienen-Set 3-türig, rechts, Aluminium, eloxiert	31517

**Garnitur bestehend aus:**

	31516	31517	Nr.
 Doppellaufschiene oben links, Aluminium, eloxiert, L= 820 mm	1		31339
 Laufschiene vorne, Aluminium, eloxiert, L= 1954 mm	1	1	31341
 Laufschienenbogen, links, Aluminium, eloxiert	1		31365
 Führungsschiene unten links, Aluminium, eloxiert, L= 820 mm	1		31336
 Connector, oben links, L= 788 mm	1		31370
 Verbindungsprofil Connector, oben, Aluminium, L= 660 mm	1	1	30977
 Connector-Clips, unten, Kunststoff, schwarz, L= 94 mm	3	3	31086
 Verbindungsstück für Laufschienenbogen, Stahl, verzinkt	1	1	31543
 Abstützung Doppellaufschiene, Kunststoff, schwarz	1	1	31359
 Laufschienenadapter, Kunststoff, anthrazit, Set à 6 Stück	1	1	24870
 Anschlagset 3-türig Push/Pull	1	1	31538
 Senkkopfschraube für Laufschienenadapter, 4,5x16 mm, Set à 24 Stück	1	1	31587

Fortsetzung Tabelle auf nächster Spalte







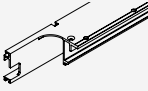
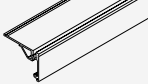

Fortsetzung Tabelle von vorheriger Spalte

 Doppellaufschiene oben rechts, Aluminium, eloxiert, L= 820 mm	1		31340
 Laufschienenbogen, rechts, Aluminium, eloxiert	1		31366
 Führungsschiene unten rechts, Aluminium, eloxiert, L= 820 mm	1		31337
 Connector, oben rechts, L= 788 mm	1		31371

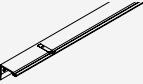
**Dazu passende Schienen-Sets 2- und 4-türig, Aluminium, schwarz eloxiert**

	Nr.
Hawa Folding Concepta III 20/25, Schienen-Set 2-türig, links, Aluminium, schwarz eloxiert	31521
Hawa Folding Concepta III 20/25, Schienen-Set 2-türig, rechts, Aluminium, schwarz eloxiert	31522
Hawa Folding Concepta III 20/25, Schienen-Set 4-türig, Aluminium, schwarz eloxiert	31525

**Garnitur bestehend aus:**

		31521	31522	31525	Nr.
	Doppelaufschiene oben links, Aluminium, eloxiert, L= 820 mm	1		1	31339
	Laufschiene vorne, Aluminium, schwarz eloxiert, L= 1272 mm	1	1		31211
	Laufschienenbogen, links, Aluminium, schwarz eloxiert	1		1	31367
	Führungsschiene unten links, Aluminium, eloxiert, L= 820 mm	1		1	31336
	Connector, oben links, L= 788 mm	1		1	31370
	Verbindungsprofil Connector, oben, Aluminium, L= 660 mm	1	1	2	30977
	Connector-Clips, unten, Kunststoff, schwarz, L= 94 mm	3	3	6	31086
	Verbindungsstück für Laufschienenbogen, Stahl, verzinkt	1	1	2	31543
	Abstützung Doppelaufschiene, Kunststoff, schwarz	1	1	2	31359
	Laufschienenadapter, Kunststoff, anthrazit, Set à 4 Stück	1	1	2	23645
	Senkkopfschraube für Laufschienenadapter, 4.5x16 mm, Set à 16 Stück	1	1	2	31585

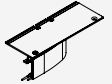
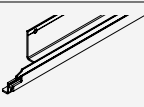
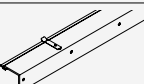
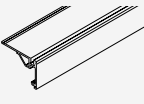

Fortsetzung Tabelle auf nächster Spalte

Fortsetzung Tabelle von vorheriger Spalte

	Abdeckstift schwarz	1	1	1	52117
	Doppelaufschiene oben rechts, Aluminium, eloxiert, L= 820 mm		1	1	31340
	Laufschienenbogen, rechts, Aluminium, schwarz eloxiert		1	1	31368
	Führungsschiene unten rechts, Aluminium, eloxiert, L= 820 mm		1	1	31337
	Connector, oben rechts, L= 788 mm		1	1	31371
	Laufschiene vorne, Aluminium, schwarz eloxiert, L= 2539 mm			1	31344

**Holm-Set, Aluminium, schwarz eloxiert**

	Nr.
Hawa Folding Concepta III 20, Holm-Set, Türhöhe 1200–2200 mm, Aluminium, schwarz eloxiert	31526

		31526	Nr.
	Holmprofil, für Türhöhe 1200–2200 mm, Aluminium, eloxiert, L= 1974 mm	1	30778
	Abdeckblende für Türfuge, für Türhöhe 1200–2200 mm, Aluminium, schwarz eloxiert, L= 2200 mm	1	31231
	Halteclip für Abdeckblende 2200 mm, Kunststoff, schwarz, Set à 6 Stück	1	31502

**Garnitur bestehend aus:**



**Dazu passende Schienen-Sets 3-türig,  
Aluminium, schwarz eloxiert**

	Nr.
Hawa Folding Concepta III 20/25, Schienen-Set 3-türig, links, Aluminium, schwarz eloxiert	31523
Hawa Folding Concepta III 20/25, Schienen-Set 3-türig, rechts, Aluminium, schwarz eloxiert	31524

**Garnitur bestehend aus:**

	31523	31524	Nr.
 Doppellaufschiene oben links, Aluminium, eloxiert, L= 820 mm	1		31339
 Laufschiene vorne, Aluminium, schwarz eloxiert, L= 1954 mm	1	1	31342
 Laufschienenbogen, links, Aluminium, schwarz eloxiert	1		31367
 Führungsschiene unten links, Aluminium, eloxiert, L= 820 mm	1		31336
 Connector, oben links, L= 788 mm	1		31370
 Verbindungsprofil Connector, oben, Aluminium, L= 660 mm	1	1	30977
 Connector-Clips, unten, Kunststoff, schwarz, L= 94 mm	3	3	31086
 Verbindungsstück für Laufschienenbogen, Stahl, verzinkt	1	1	31543
 Abstützung Doppellaufschiene, Kunststoff, schwarz	1	1	31359
 Laufschienenadapter, Kunststoff, anthrazit, Set à 6 Stück	1	1	24870
 Anschlagset 3-türig Push/Pull	1	1	31538
 Senkkopfschraube für Laufschienenadapter, 4,5x16 mm, Set à 24 Stück	1	1	31587

Fortsetzung Tabelle auf nächster Spalte

Fortsetzung Tabelle von vorheriger Spalte

 Abdeckstift schwarz	1	1	52117
 Doppellaufschiene oben rechts, Aluminium, eloxiert, L= 820 mm		1	31340
 Laufschienenbogen, rechts, Aluminium, schwarz eloxiert		1	31368
 Führungsschiene unten rechts, Aluminium, eloxiert, L= 820 mm		1	31337
 Connector, oben rechts, L= 788 mm		1	31371



**Verstärkungsprofile**

	Nr.
 Verstärkungsprofil für Laufschiene vorne, 2765 mm, 4-türig, Aluminium, eloxiert	52109
Verstärkungsprofil für Laufschiene vorne, 2085 mm, 3-türig, Aluminium, eloxiert	52110

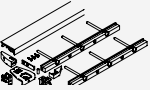
**Bodenprofile**

	Nr.
 Bodenprofil-Set, 2-türig, Aluminium, eloxiert	52089
Bodenprofil-Set, 3-türig, Aluminium, eloxiert	52090
Bodenprofil-Set, 4-türig, Aluminium, eloxiert	52091
Bodenprofil-Set, 2-türig, Aluminium, schwarz eloxiert	52092
Bodenprofil-Set, 3-türig, Aluminium, schwarz eloxiert	52093
Bodenprofil-Set, 4-türig, Aluminium, schwarz eloxiert	52094

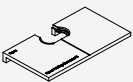
**Zubehör**

	Nr.
 Einfrässhablone für Faltscharnier	52121
 Zentrierteil magnetisch, mit Bohrlehre, Aluminium, eloxiert	24006

**Ausrichtbeschlag**

→ Details unter Zubehör ab Seite 315

**Aluminium, roh**

	Nr.
 Ausrichtbeschlag für Türen 1715–2275 mm, Aluminium	056.3192.079
Ausrichtbeschlag für Türen 1215–1775 mm, Aluminium	056.3192.073

**Aluminium, eloxiert**

	Nr.
 Ausrichtbeschlag für Türen 1715–2275 mm, Aluminium, eloxiert, kürzbar für Türen 1215–1715 mm	056.3192.080

**Aluminium, schwarz eloxiert**

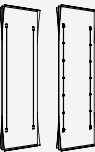
	Nr.
 Ausrichtbeschlag für Türen 1715–2275 mm, Aluminium, schwarz eloxiert	056.3192.081
Ausrichtbeschlag für Türen 1215–1775 mm, Aluminium, schwarz eloxiert	056.3192.076

**Ausrichtbeschlag**

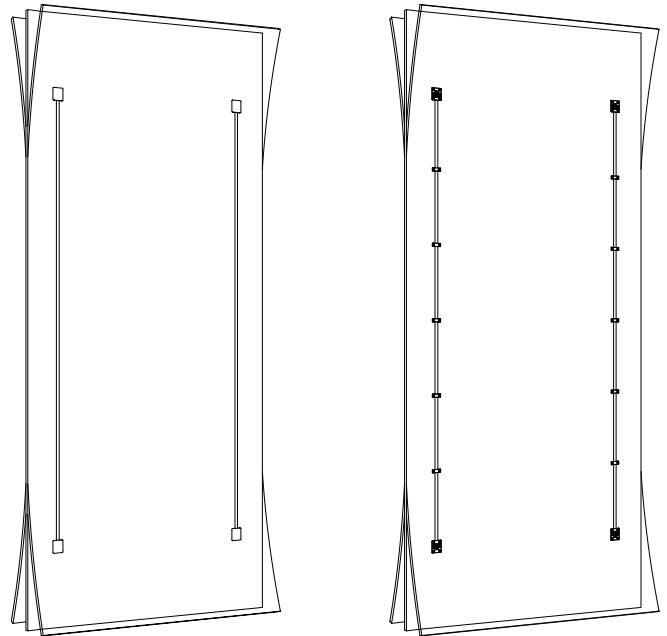

Weitere Einbaubeispiele  
Türe aufschlagend mit Bodenprofil, 2- und 4-türig

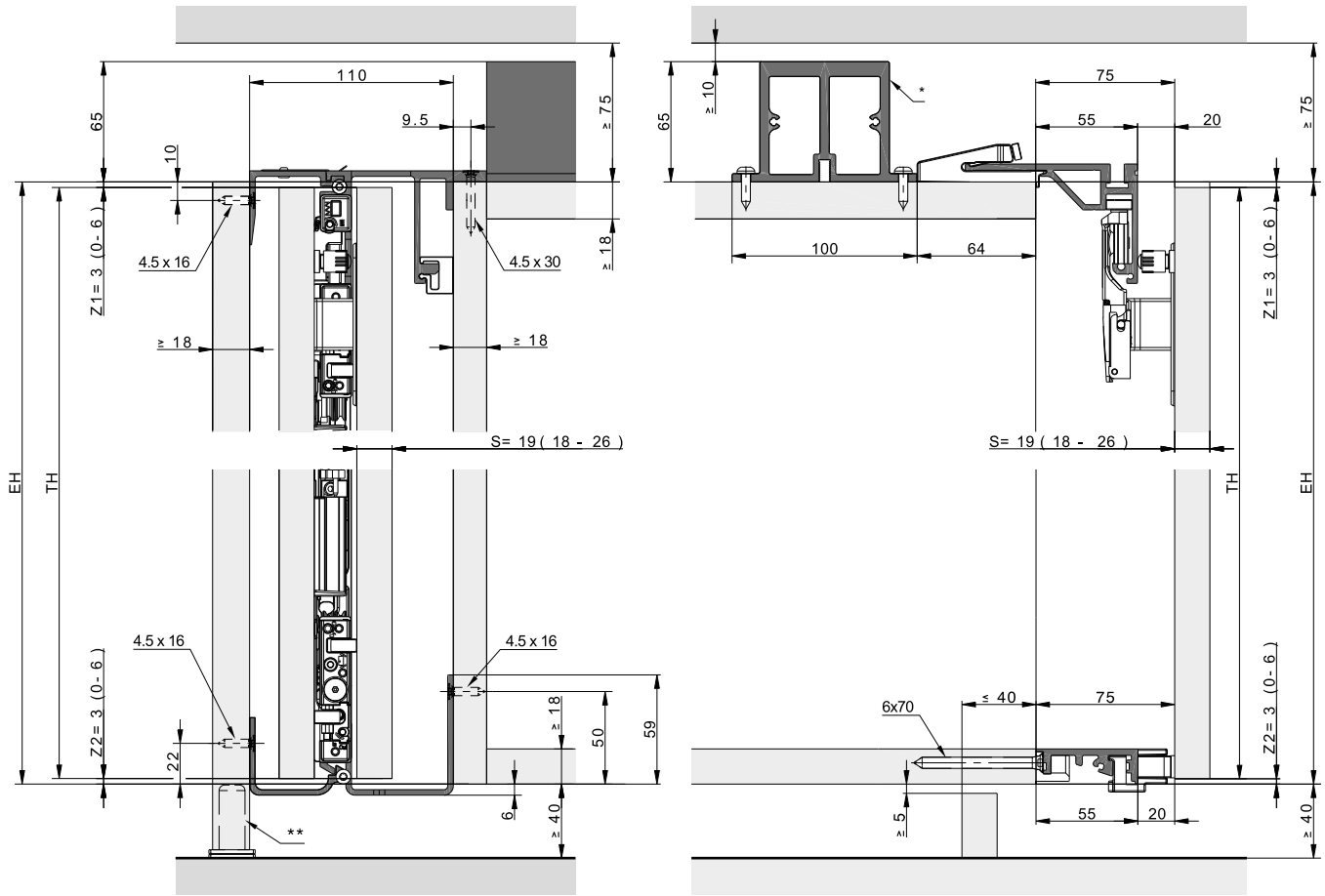

\* Verstärkungsprofil bei 3- und 4-türigen Anlagen ohne Mittelwände

\*\* Empfehlung: Stellfüsse verwenden

Raumhohe Türen ohne Möbelboden, 2- und 4-türig

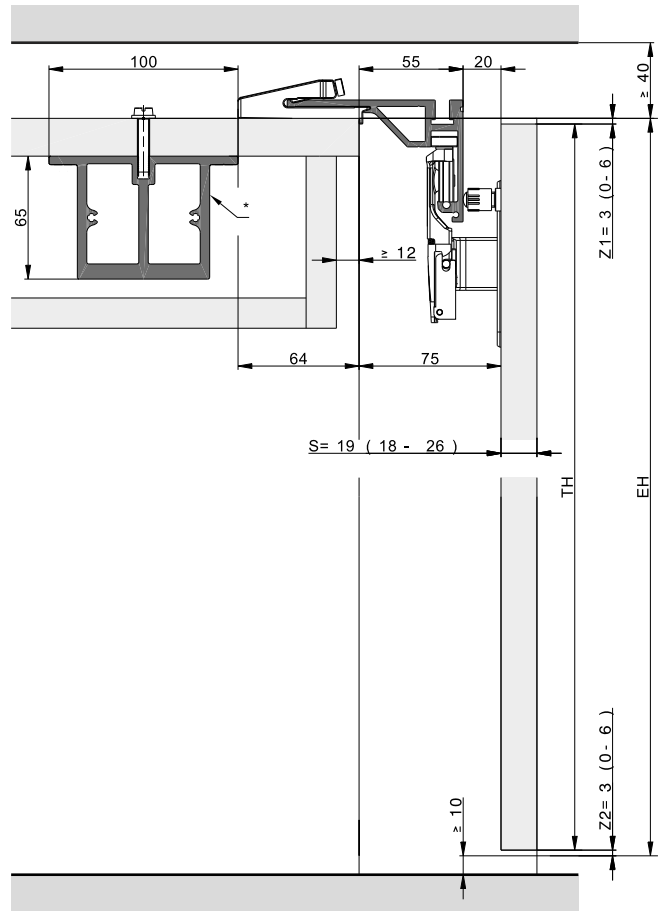
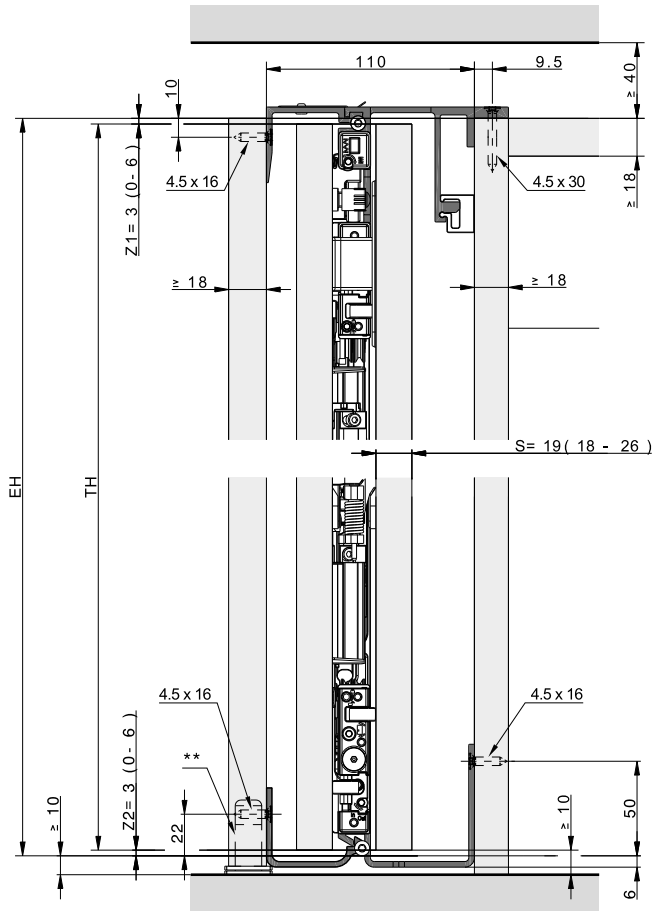

- \* Verstärkungsprofil bei 3- und 4-türigen Anlagen ohne Mittelwände
- \*\* Empfehlung: Stellfüsse verwenden

Türe aufschlagend ohne Bodenprofil, 3-türig

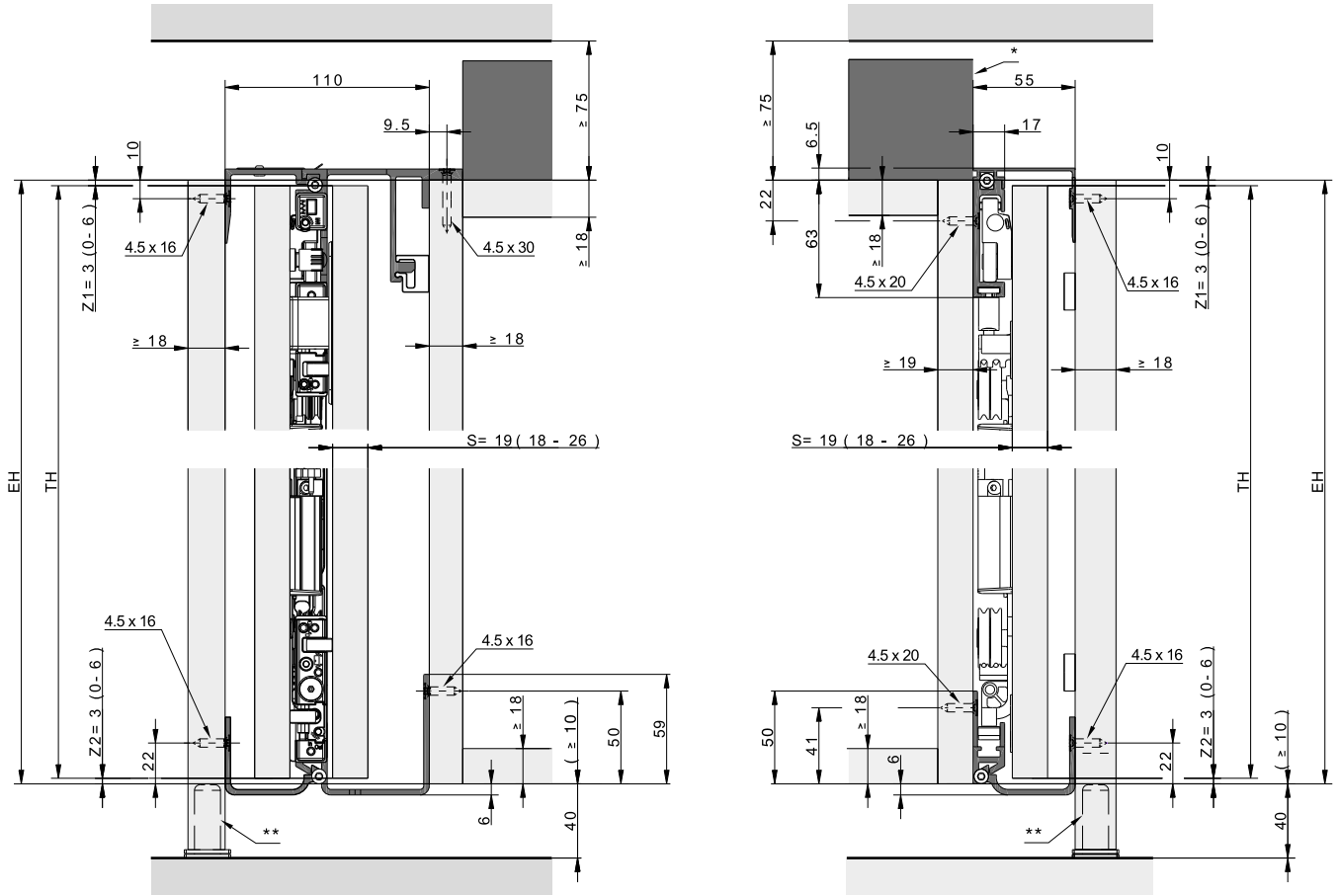

\* Verstärkungsprofil bei 3- und 4-türigen Anlagen ohne Mittelwände

\*\* Empfehlung: Stellfüsse verwenden

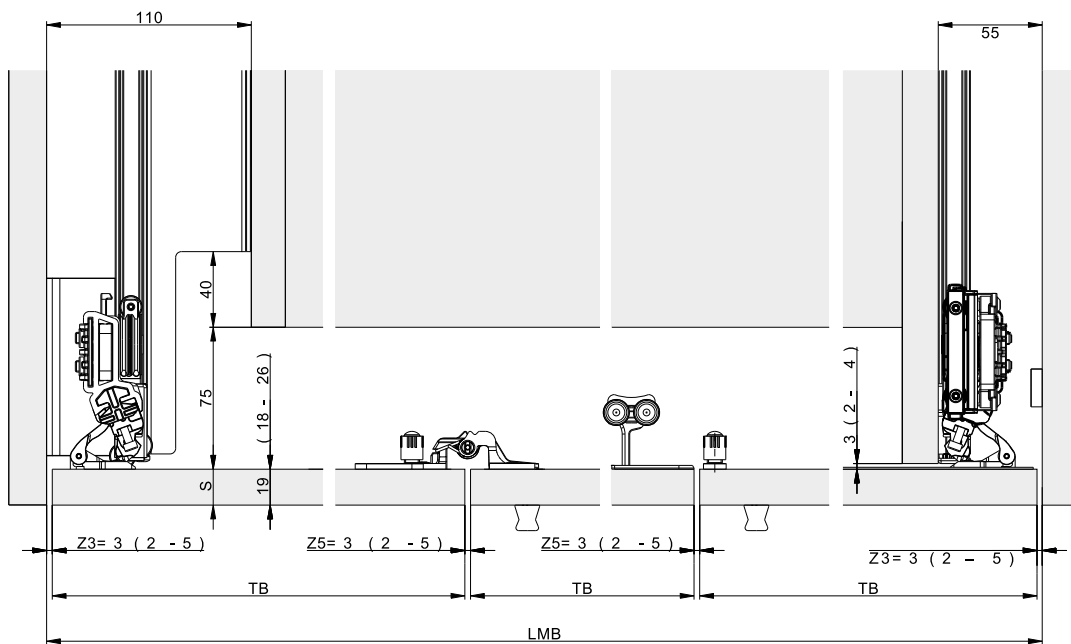

### Berechnung Beschlagstiefe

Türe bündig

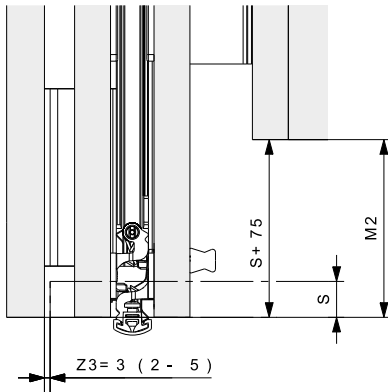

Türe vorstehend

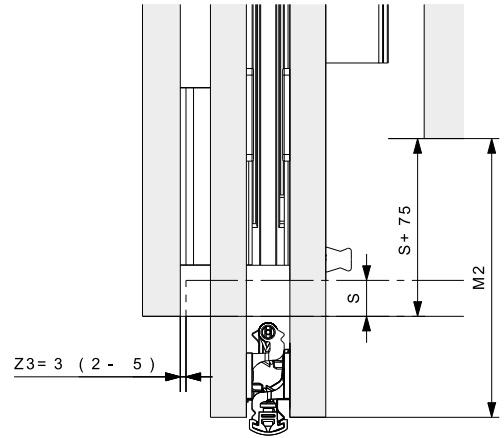

	mm
T2	$TB + 92 + Z3 - M2$
E2	$TB - M2$
KT2	$\geq T2$
M2	$\geq S + 75$ $\leq TB - 390$

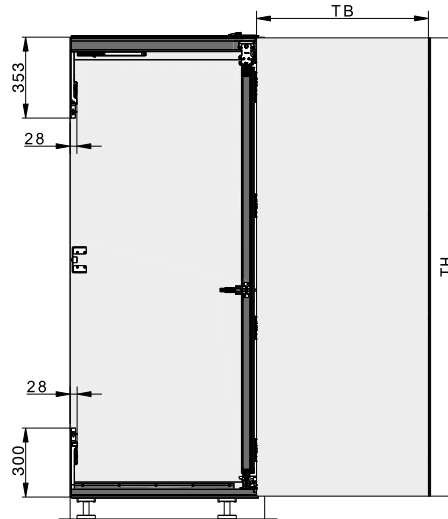
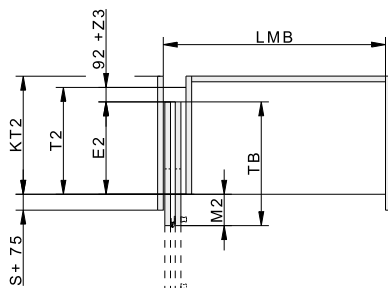

- S = Türdicke
- Z = Fugenmass
- E2 = Einschubtiefe
- T2 = Beschlagstiefe
- M2 = Türüberstand über Korpus
- TB = Türbreite
- TH = Türhöhe
- KT2 = Korpustiefe
- LMB = Lichtmassbreite

### Anleitungen

### Videos

### Zubehör

– Ausrichtbeschlag ab Seite 315

### Planung/Ausführung

Konfigurieren Sie mit nur wenigen Klicks auf [www.hawa.com/konfigurator](http://www.hawa.com/konfigurator)

Weitere Informationen zum Produkt finden Sie auf [www.hawa.com](http://www.hawa.com).