





**Beschlag zum Drehen, Falten und seitlich Einschieben von Holztüren bis 25 kg.
Einheitliche, flächenbündige Frontgestaltung mit gleichmässigem Fugenbild.
Unsichtbare Technik. Pull-Version mit Griff.**

Produkt-Highlights

-  **Flexibilität** Variable Türdimensionen, auch für raumhohe, begehbare Schränke – kombinierbar mit Hawa Concepta III
-  **Produktivität** Einfache Montage dank hohem Vormontagegrad und intuitive Justierung
-  **Komfort** Öffnen und Schliessen mit geringstem Kraftaufwand – eine Hand genügt

Technische Vorgaben

-  10–25 kg
-  1900–2700 mm
-  440–750 mm
-  18–26 mm

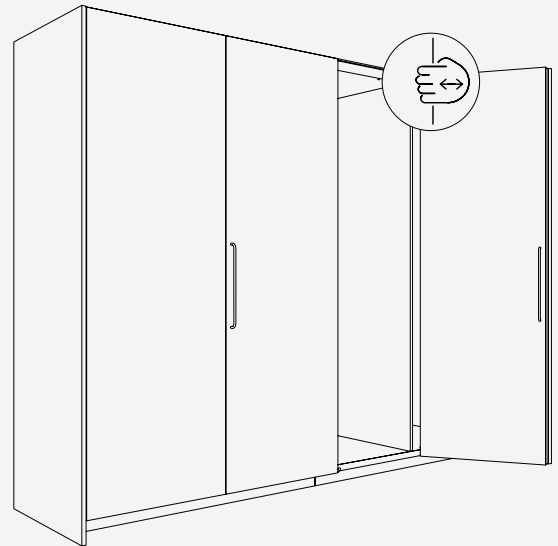

**Einbaubeispiele
Türe aufschlagend ohne Bodenprofil**

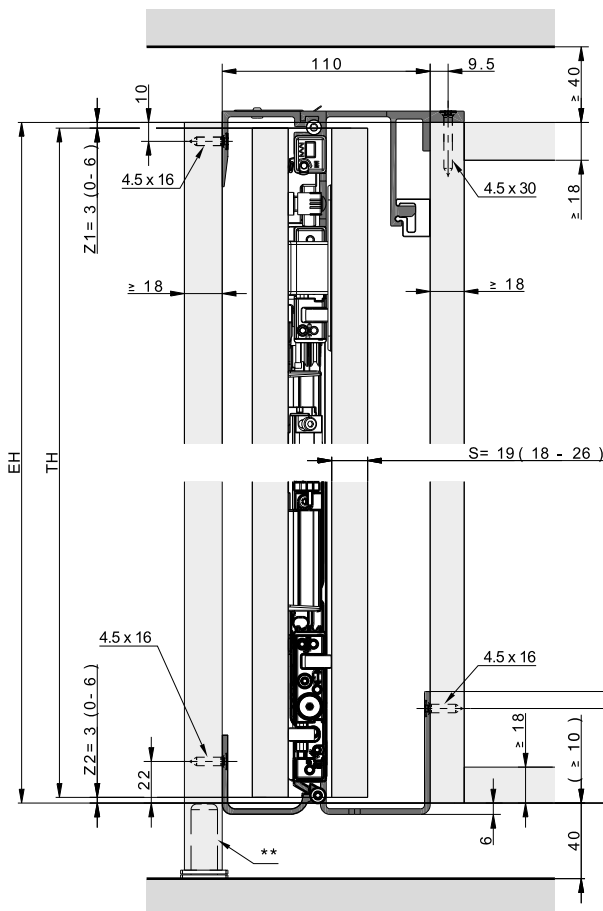

** Empfehlung: Stellfuss verwenden

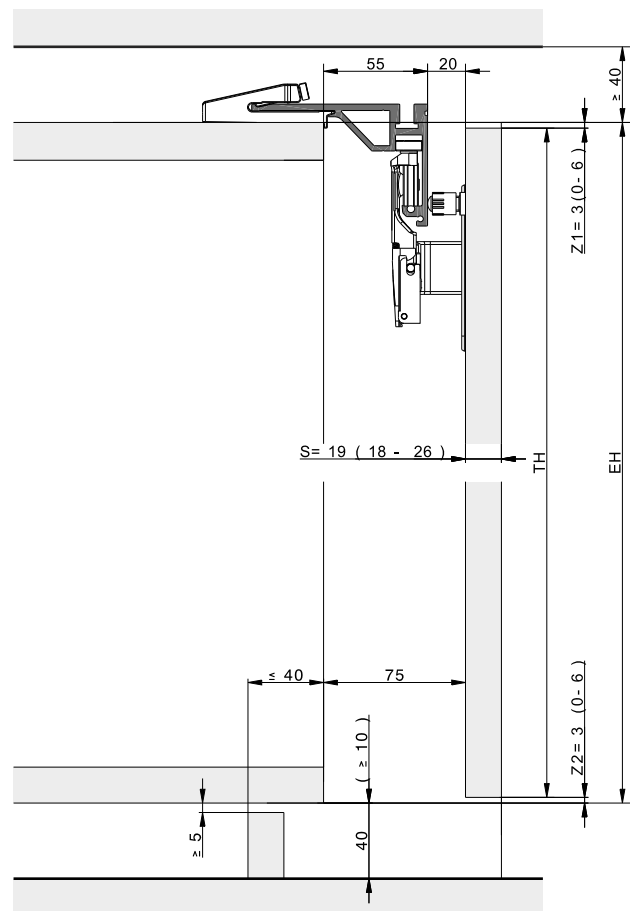

Türe aufschlagend ohne Bodenprofil, 2- und 4-türig

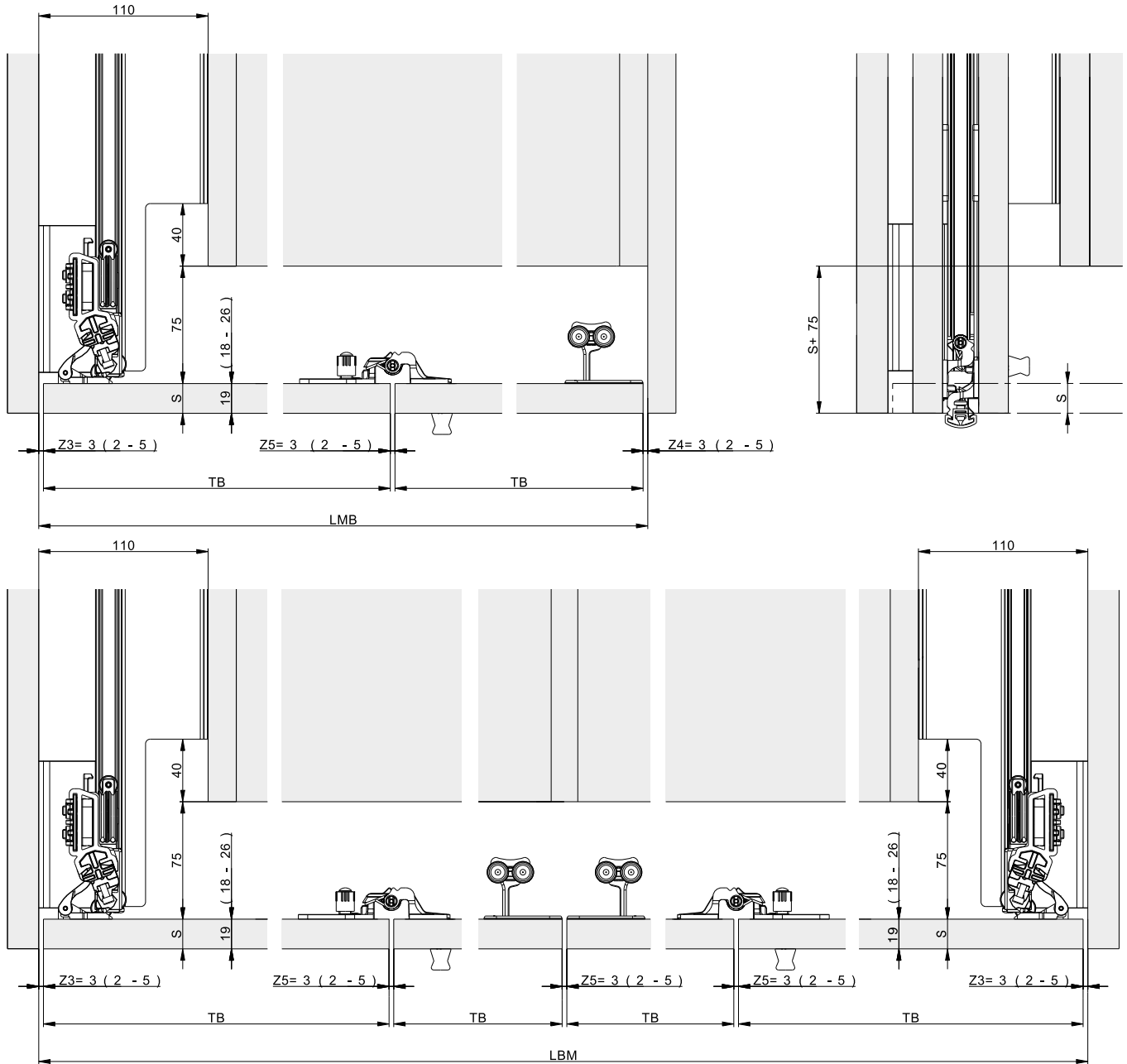

Benötigte Komponenten

für 2-türige Schränke

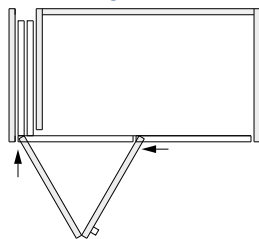

Hawa Folding Concepta III 25 Pull, links Aluminium, eloxiert

	Nr.
Hawa Folding Concepta III 25 Pull, Grundgarnitur, Türhöhe 1900–2700 mm	31507
Hawa Folding Concepta III 20/25 Pull, Einschiebegarnitur, links	31512
Hawa Folding Concepta III 20/25, Schienen-Set 2-türig, links, Aluminium, eloxiert	31514
Hawa Folding Concepta III 25, Holm-Set, Türhöhe 1900–2700 mm, Aluminium, eloxiert	31520

Aluminium, schwarz eloxiert

	Nr.
Hawa Folding Concepta III 25 Pull, Grundgarnitur, Türhöhe 1900–2700 mm	31507
Hawa Folding Concepta III 20/25 Pull, Einschiebegarnitur, links	31512
Hawa Folding Concepta III 20/25, Schienen-Set 2-türig, links, Aluminium, schwarz eloxiert	31521
Hawa Folding Concepta III 25, Holm-Set, Türhöhe 1900–2700 mm, Aluminium, schwarz eloxiert	31527

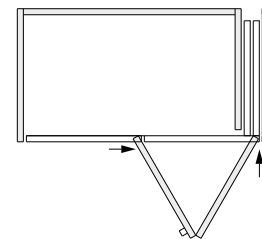

Hawa Folding Concepta III 25 Pull, rechts, Aluminium, eloxiert

	Nr.
Hawa Folding Concepta III 25 Pull, Grundgarnitur, Türhöhe 1900–2700 mm	31507
Hawa Folding Concepta III 20/25 Pull, Einschiebegarnitur, rechts	31513
Hawa Folding Concepta III 20/25, Schienen-Set 2-türig, rechts, Aluminium, eloxiert	31515
Hawa Folding Concepta III 25, Holm-Set, Türhöhe 1900–2700 mm, Aluminium, eloxiert	31520

Aluminium, schwarz eloxiert

	Nr.
Hawa Folding Concepta III 25 Pull, Grundgarnitur, Türhöhe 1900–2700 mm	31507
Hawa Folding Concepta III 20/25 Pull, Einschiebegarnitur, rechts	31513
Hawa Folding Concepta III 20/25, Schienen-Set 2-türig, rechts, Aluminium, schwarz eloxiert	31522
Hawa Folding Concepta III 25, Holm-Set, Türhöhe 1900–2700 mm, Aluminium, schwarz eloxiert	31527

für 4-türige Schränke

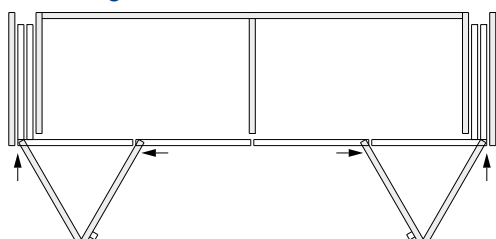

Hawa Folding Concepta III 25 Pull links/rechts

Aluminium, eloxiert

	Stk.	Nr.
Hawa Folding Concepta III 25 Pull, Grundgarnitur, Türhöhe 1900–2700 mm	2	31507
Hawa Folding Concepta III 20/25 Pull, Einschiebegarnitur, links	1	31512
Hawa Folding Concepta III 20/25 Pull, Einschiebegarnitur, rechts	1	31513
Hawa Folding Concepta III 20/25, Schienen-Set 4-türig, Aluminium, eloxiert	1	31518
Hawa Folding Concepta III 25, Holm-Set, Türhöhe 1900–2700 mm, Aluminium, eloxiert	2	31520

Aluminium, schwarz eloxiert

	Stk.	Nr.
Hawa Folding Concepta III 25 Pull, Grundgarnitur, Türhöhe 1900–2700 mm	2	31507
Hawa Folding Concepta III 20/25 Pull, Einschiebegarnitur, links	1	31512
Hawa Folding Concepta III 20/25 Pull, Einschiebegarnitur, rechts	1	31513
Hawa Folding Concepta III 20/25, Schienen-Set 4-türig, Aluminium, schwarz eloxiert	1	31525
Hawa Folding Concepta III 25, Holm-Set, Türhöhe 1900–2700 mm, Aluminium, schwarz eloxiert	2	31527

für 3-türige Schränke

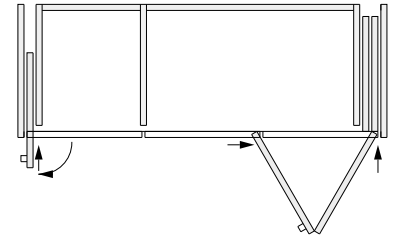
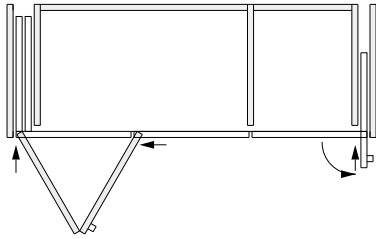

**Hawa Folding Concepta III 25 Pull, links mit
Hawa Concepta III 35 Pull, rechts**

Aluminium, eloxiert

	Nr.
Hawa Folding Concepta III 25 Pull, Grundgarnitur, Türhöhe 1900–2700 mm	31507
Hawa Folding Concepta III 20/25 Pull, Einschriebegarnitur, links	31512
Hawa Folding Concepta III 20/25, Schienen-Set 3-türig, links, Aluminium, eloxiert	31516
Hawa Folding Concepta III 25, Holm-Set, Türhöhe 1900–2700 mm, Aluminium, eloxiert	31520
Hawa Concepta III 35 Push/Pull, Grundgarnitur rechts, Türhöhe 1900–2700 mm	30997
Hawa Concepta III 25/35 Pull, Einschriebegarnitur, rechts	31001
Holmprofil, für Türhöhe 1900–2700 mm, Aluminium, eloxiert, L= 2474 mm	30771
Connector-Set 55 mm, für Verbindung Aussenseite mit Korpus	31005

Aluminium, schwarz eloxiert

	Nr.
Hawa Folding Concepta III 25 Pull, Grundgarnitur, Türhöhe 1900–2700 mm	31507
Hawa Folding Concepta III 20/25 Pull, Einschriebegarnitur, links	31512
Hawa Folding Concepta III 20/25, Schienen-Set 3-türig, links, Aluminium, schwarz eloxiert	31523
Hawa Folding Concepta III 25, Holm-Set, Türhöhe 1900–2700 mm, Aluminium, schwarz eloxiert	31527
Hawa Concepta III 35 Push/Pull, Grundgarnitur rechts, Türhöhe 1900–2700 mm	30997
Hawa Concepta III 25/35 Pull, Einschriebegarnitur, rechts	31001
Holmprofil, für Türhöhe 1900–2700 mm, Aluminium, eloxiert, L= 2474 mm	30771
Connector-Set 55 mm, für Verbindung Aussenseite mit Korpus	31005

**Hawa Folding Concepta III 25 Pull, rechts mit
Hawa Concepta III 35 Pull, links**

Aluminium, eloxiert

	Nr.
Hawa Folding Concepta III 25 Pull, Grundgarnitur, Türhöhe 1900–2700 mm	31507
Hawa Folding Concepta III 20/25 Pull, Einschriebegarnitur, rechts	31513
Hawa Folding Concepta III 20/25, Schienen-Set 3-türig, rechts, Aluminium, eloxiert	31517
Hawa Folding Concepta III 25, Holm-Set, Türhöhe 1900–2700 mm, Aluminium, eloxiert	31520
Hawa Concepta III 35 Push/Pull, Grundgarnitur links, Türhöhe 1900–2700 mm	30996
Hawa Concepta III 25/35 Pull, Einschriebegarnitur, links	31000
Holmprofil, für Türhöhe 1900–2700 mm, Aluminium, eloxiert, L= 2474 mm	30771
Connector-Set 55 mm, für Verbindung Aussenseite mit Korpus	31005











Aluminium, schwarz eloxiert

	Nr.
Hawa Folding Concepta III 25 Pull, Grundgarnitur, Türhöhe 1900–2700 mm	31507
Hawa Folding Concepta III 20/25 Pull, Einschriebegarnitur, rechts	31513
Hawa Folding Concepta III 20/25, Schienen-Set 3-türig, rechts, Aluminium, schwarz eloxiert	31524
Hawa Folding Concepta III 25, Holm-Set, Türhöhe 1900–2700 mm, Aluminium, schwarz eloxiert	31527
Hawa Concepta III 35 Push/Pull, Grundgarnitur links, Türhöhe 1900–2700 mm	30996
Hawa Concepta III 25/35 Pull, Einschriebegarnitur, links	31000
Holmprofil, für Türhöhe 1900–2700 mm, Aluminium, eloxiert, L= 2474 mm	30771
Connector-Set 55 mm, für Verbindung Aussenseite mit Korpus	31005





Hawa Konfigurator

Auflistung der Einzelteile, welche in den Garnituren enthalten sind

Garnitur für 1 falt-Einschiebetüre bis 25 kg

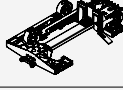
		Nr.			
Hawa Folding Concepta III 25 Pull, Grundgarnitur, Türhöhe 1900–2700 mm		31507			
		31507	Nr.		
Garnitur bestehend aus:					
	Nutensteine für Scharnierbefestigung, Kunststoff, schwarz			4	30686
	Scharnieraufnahme mit Höheneinstellung, Stahl, vernickelt			1	30738
	Topfscharnier, mit Dämpfung und Schliessfeder, Stahl, vernickelt			4	31070
	Mitteltopfscharnier, ungefedert, Stahl, matt vernickelt			4	31362
	Schraube für Topf- und Mitteltopfscharniere, 4x16 mm, Set à 26 Stück			1	31533
	Faltlaufwerk, vernickelt			1	31313
	Faltlaufwerkscharnier			1	31314
	Dämpfeinzug mit Endanschlag			1	31222
	Anschlagpuffer verstellbar, Kunststoff, anthrazit			1	31550
	Justierwerkzeug-Set	1	31047		
	Senkkopfschraube, 4.5x16 mm, Stahl, verzinkt, Set à 28 Stück	1	31529		
	Schrauben-Set für Doppelaufschiene und Connectorfixierung unten	1	31530		

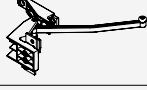





Dazu passende Einschiebegarnitur

		Nr.					
Hawa Folding Concepta III 20/25 Pull, Einschiebegarnitur, links		31512					
Hawa Folding Concepta III 20/25 Pull, Einschiebegarnitur, rechts		31513					
		31512	31513	Nr.			
Garnitur bestehend aus:							
	Einschiebeeinheit Hawa Folding Concepta III 20/25 Pull, links				1	31004	
	Endanschlagwinkel Pull, Stahl, verzinkt				1	1	31541
	Einschiebesicherung, Kunststoff, schwarz				1	1	30966
	Einschiebeeinheit Hawa Folding Concepta III 20/25 Pull, rechts		1	31046			

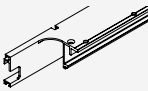
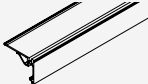
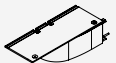
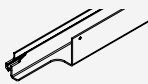
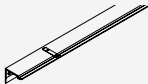
Dazu passende Schienen-Sets 2- und 4-türig, Aluminium, eloxiert

	Nr.
Hawa Folding Concepta III 20/25, Schienen-Set 2-türig, links, Aluminium, eloxiert	31514
Hawa Folding Concepta III 20/25, Schienen-Set 2-türig, rechts, Aluminium, eloxiert	31515
Hawa Folding Concepta III 20/25, Schienen-Set 4-türig, Aluminium, eloxiert	31518

Garnitur bestehend aus:

	31514	31515	31518	Nr.
 Doppellaufschiene oben links, Aluminium, eloxiert, L= 820 mm	1		1	31339
 Laufschiene vorne, Aluminium, eloxiert, L= 1272 mm	1	1		31210
 Laufschienenbogen, links, Aluminium, eloxiert	1		1	31365
 Führungsschiene unten links, Aluminium, eloxiert, L= 820 mm	1		1	31336
 Connector, oben links, L= 788 mm	1		1	31370
 Verbindungsprofil Connector, oben, Aluminium, L= 660 mm	1	1	2	30977
 Connector-Clips, unten, Kunststoff, schwarz, L= 94 mm	3	3	6	31086
 Verbindungsstück für Laufschienenbogen, Stahl, verzinkt	1	1	2	31543
 Abstützung Doppellaufschiene, Kunststoff, schwarz	1	1	2	31359
 Laufschienenadapter, Kunststoff, anthrazit, Set à 4 Stück	1	1	2	23645
 Senkkopfschraube für Laufschienenadapter, 4.5x16 mm, Set à 16 Stück	1	1	2	31585

Fortsetzung Tabelle auf nächster Spalte



Fortsetzung Tabelle von vorheriger Spalte

 Doppellaufschiene oben rechts, Aluminium, eloxiert, L= 820 mm		1	1	31340
 Laufschienenbogen, rechts, Aluminium, eloxiert		1	1	31366
 Führungsschiene unten rechts, Aluminium, eloxiert, L= 820 mm		1	1	31337
 Connector, oben rechts, L= 788 mm		1	1	31371
 Laufschiene vorne, Aluminium, eloxiert, L= 2539 mm			1	31343

Holm-Set, Aluminium, eloxiert

	Nr.
Hawa Folding Concepta III 25, Holm-Set, Türhöhe 1900–2700 mm, Aluminium, eloxiert	31520

Garnitur bestehend aus:

	31520	Nr.
 Holmprofil, für Türhöhe 1900–2700 mm, Aluminium, eloxiert, L= 2474 mm	1	30771
 Abdeckblende für Türfuge, für Türhöhe 1900–2700 mm, Aluminium, eloxiert, L= 2700 mm	1	31232
 Halteclip für Abdeckblende 2700 mm, Kunststoff, schwarz, Set à 8 Stück	1	31503

**Dazu passende Schienen-Sets 3-türig,
Aluminium, eloxiert**



	Nr.
Hawa Folding Concepta III 20/25, Schienen-Set 3-türig, links, Aluminium, eloxiert	31516
Hawa Folding Concepta III 20/25, Schienen-Set 3-türig, rechts, Aluminium, eloxiert	31517

Garnitur bestehend aus:

	31516	31517	Nr.
 Doppellaufschiene oben links, Aluminium, eloxiert, L= 820 mm	1		31339
 Laufschiene vorne, Aluminium, eloxiert, L= 1954 mm	1	1	31341
 Laufschienenbogen, links, Aluminium, eloxiert	1		31365
 Führungsschiene unten links, Aluminium, eloxiert, L= 820 mm	1		31336
 Connector, oben links, L= 788 mm	1		31370
 Verbindungsprofil Connector, oben, Aluminium, L= 660 mm	1	1	30977
 Connector-Clips, unten, Kunststoff, schwarz, L= 94 mm	3	3	31086
 Verbindungsstück für Laufschienenbogen, Stahl, verzinkt	1	1	31543
 Abstützung Doppellaufschiene, Kunststoff, schwarz	1	1	31359
 Laufschienenadapter, Kunststoff, anthrazit, Set à 6 Stück	1	1	24870
 Anschlagset 3-türig Push/Pull	1	1	31538
 Senkkopfschraube für Laufschienenadapter, 4,5x16 mm, Set à 24 Stück	1	1	31587

Fortsetzung Tabelle auf nächster Spalte

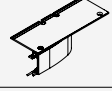





Fortsetzung Tabelle von vorheriger Spalte

	Doppellaufschiene oben rechts, Aluminium, eloxiert, L= 820 mm	1	31340
	Laufschienenbogen, rechts, Aluminium, eloxiert	1	31366
	Führungsschiene unten rechts, Aluminium, eloxiert, L= 820 mm	1	31337
	Connector, oben rechts, L= 788 mm	1	31371

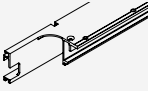
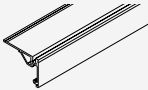
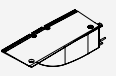
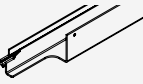
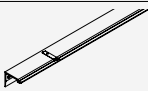
Dazu passende Schienen-Sets 2- und 4-türig, Aluminium, schwarz eloxiert



	Nr.
Hawa Folding Concepta III 20/25, Schienen-Set 2-türig, links, Aluminium, schwarz eloxiert	31521
Hawa Folding Concepta III 20/25, Schienen-Set 2-türig, rechts, Aluminium, schwarz eloxiert	31522
Hawa Folding Concepta III 20/25, Schienen-Set 4-türig, Aluminium, schwarz eloxiert	31525

Garnitur bestehend aus:

		31521	31522	31525	Nr.
	Doppellaufschiene oben links, Aluminium, eloxiert, L= 820 mm	1		1	31339
	Laufschiene vorne, Aluminium, schwarz eloxiert, L= 1272 mm	1	1		31211
	Laufschienenbogen, links, Aluminium, schwarz eloxiert	1		1	31367
	Führungsschiene unten links, Aluminium, eloxiert, L= 820 mm	1		1	31336
	Connector, oben links, L= 788 mm	1		1	31370
	Verbindungsprofil Connector, oben, Aluminium, L= 660 mm	1	1	2	30977
	Connector-Clips, unten, Kunststoff, schwarz, L= 94 mm	3	3	6	31086
	Verbindungsstück für Laufschienenbogen, Stahl, verzinkt	1	1	2	31543
	Abstützung Doppellaufschiene, Kunststoff, schwarz	1	1	2	31359
	Laufschienenadapter, Kunststoff, anthrazit, Set à 4 Stück	1	1	2	23645
	Senkkopfschraube für Laufschienenadapter, 4.5x16 mm, Set à 16 Stück	1	1	2	31585

Fortsetzung Tabelle auf nächster Spalte

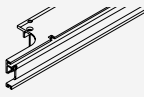
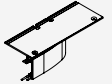

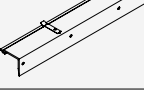
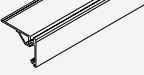
Fortsetzung Tabelle von vorheriger Spalte

	Abdeckstift schwarz	1	1	1	52117
	Doppellaufschiene oben rechts, Aluminium, eloxiert, L= 820 mm		1	1	31340
	Laufschienenbogen, rechts, Aluminium, schwarz eloxiert		1	1	31368
	Führungsschiene unten rechts, Aluminium, eloxiert, L= 820 mm		1	1	31337
	Connector, oben rechts, L= 788 mm		1	1	31371
	Laufschiene vorne, Aluminium, schwarz eloxiert, L= 2539 mm			1	31344

Holm-Set, Aluminium, schwarz eloxiert

	Nr.
Hawa Folding Concepta III 25, Holm-Set, Türhöhe 1900–2700 mm, Aluminium, schwarz eloxiert	31527

Garnitur bestehend aus:

		31527	Nr.
	Holmprofil, für Türhöhe 1900–2700 mm, Aluminium, eloxiert, L= 2474 mm	1	30771
	Abdeckblende für Türfuge, für Türhöhe 1900–2700 mm, Aluminium, schwarz eloxiert, L= 2700 mm	1	31233
	Halteclip für Abdeckblende 2700 mm, Kunststoff, schwarz, Set à 8 Stück	1	31503

**Dazu passende Schienen-Sets 3-türig,
Aluminium, schwarz eloxiert**

	Nr.
Hawa Folding Concepta III 20/25, Schienen-Set 3-türig, links, Aluminium, schwarz eloxiert	31523
Hawa Folding Concepta III 20/25, Schienen-Set 3-türig, rechts, Aluminium, schwarz eloxiert	31524

Garnitur bestehend aus:			Nr.
	31523	31524	
 Doppellaufschiene oben links, Aluminium, eloxiert, L= 820 mm	1		31339
 Laufschiene vorne, Aluminium, schwarz eloxiert, L= 1954 mm	1	1	31342
 Laufschienenbogen, links, Aluminium, schwarz eloxiert	1		31367
 Führungsschiene unten links, Aluminium, eloxiert, L= 820 mm	1		31336
 Connector, oben links, L= 788 mm	1		31370
 Verbindungsprofil Connector, oben, Aluminium, L = 660 mm	1	1	30977
 Connector-Clips, unten, Kunststoff, schwarz, L= 94 mm	3	3	31086
 Verbindungsstück für Laufschienenbogen, Stahl, verzinkt	1	1	31543
 Abstützung Doppellaufschiene, Kunststoff, schwarz	1	1	31359
 Laufschienenadapter, Kunststoff, anthrazit, Set à 6 Stück	1	1	24870
 Anschlagset 3-türig Push/Pull	1	1	31538
 Senkkopfschraube für Laufschienenadapter, 4,5x16 mm, Set à 24 Stück	1	1	31587

Fortsetzung Tabelle auf nächster Spalte

Fortsetzung Tabelle von vorheriger Spalte

 Abdeckstift schwarz	1	1	52117
 Doppellaufschiene oben rechts, Aluminium, eloxiert, L= 820 mm		1	31340
 Laufschienenbogen, rechts, Aluminium, schwarz eloxiert		1	31368
 Führungsschiene unten rechts, Aluminium, eloxiert, L= 820 mm		1	31337
 Connector, oben rechts, L= 788 mm		1	31371

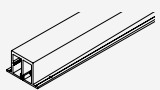

Verstärkungsprofile

	Nr.
 Verstärkungsprofil für Laufschiene vorne, 2765 mm, 4-türig, Aluminium, eloxiert	52109
Verstärkungsprofil für Laufschiene vorne, 2085 mm, 3-türig, Aluminium, eloxiert	52110

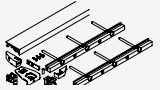
Bodenprofile

	Nr.
 Bodenprofil-Set, 2-türig, Aluminium, eloxiert	52089
Bodenprofil-Set, 3-türig, Aluminium, eloxiert	52090
Bodenprofil-Set, 4-türig, Aluminium, eloxiert	52091
Bodenprofil-Set, 2-türig, Aluminium, schwarz eloxiert	52092
Bodenprofil-Set, 3-türig, Aluminium, schwarz eloxiert	52093
Bodenprofil-Set, 4-türig, Aluminium, schwarz eloxiert	52094

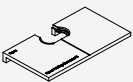
Zubehör

	Nr.
 Einfrässchablone für Faltscharnier	52121
 Zentrierteil magnetisch, mit Bohrlehre, Aluminium, eloxiert	24006

Ausrichtbeschlag

→ Details unter Zubehör ab Seite 315

Aluminium, roh

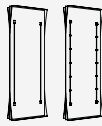
	Nr.
 Ausrichtbeschlag für Türen 2040–2600 mm, Aluminium	056.3192.072
Ausrichtbeschlag für Türen 1715–2275 mm, Aluminium	056.3192.079

Aluminium, eloxiert

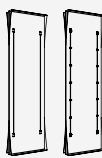
	Nr.
 Ausrichtbeschlag für Türen 2240–2850 mm, Aluminium, eloxiert	056.3192.071
Ausrichtbeschlag für Türen 2040–2600 mm, Aluminium, eloxiert	056.3192.082

Aluminium, schwarz eloxiert

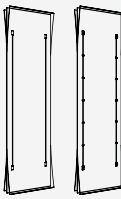
	Nr.
 Ausrichtbeschlag für Türen 2240–2850 mm, Aluminium, schwarz eloxiert	056.3192.074
Ausrichtbeschlag für Türen 2040–2600 mm, Aluminium, schwarz eloxiert	056.3192.075
Ausrichtbeschlag für Türen 1715–2275 mm, Aluminium, schwarz eloxiert	056.3192.081

Ausrichtbeschlag

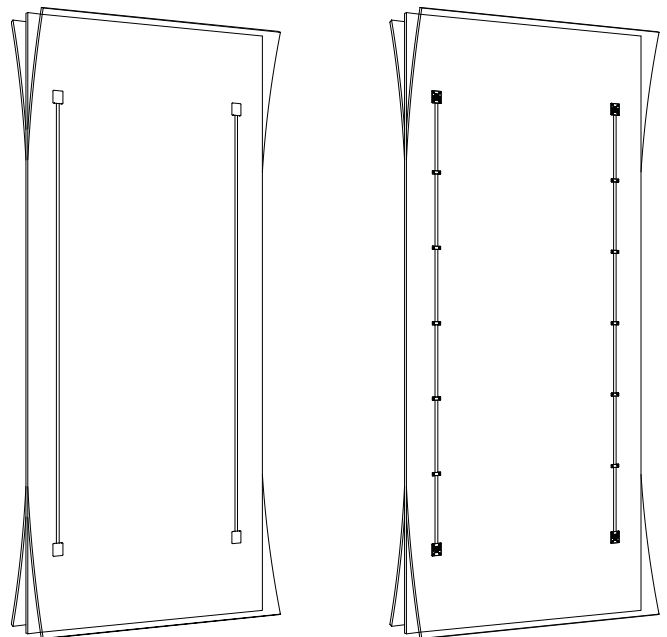

Raumhohe Türen ohne Möbelboden, 2- und 4-türig

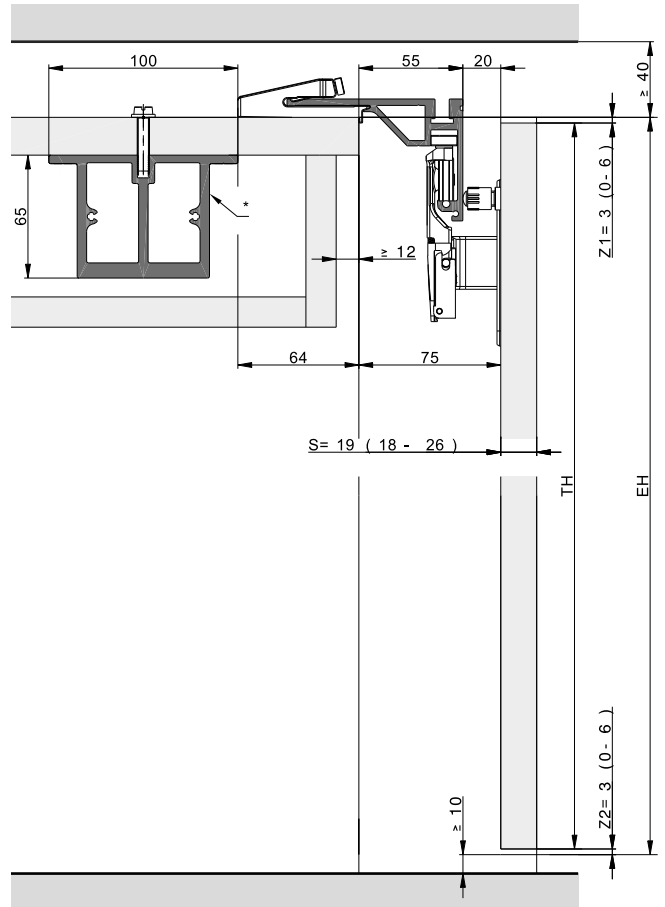
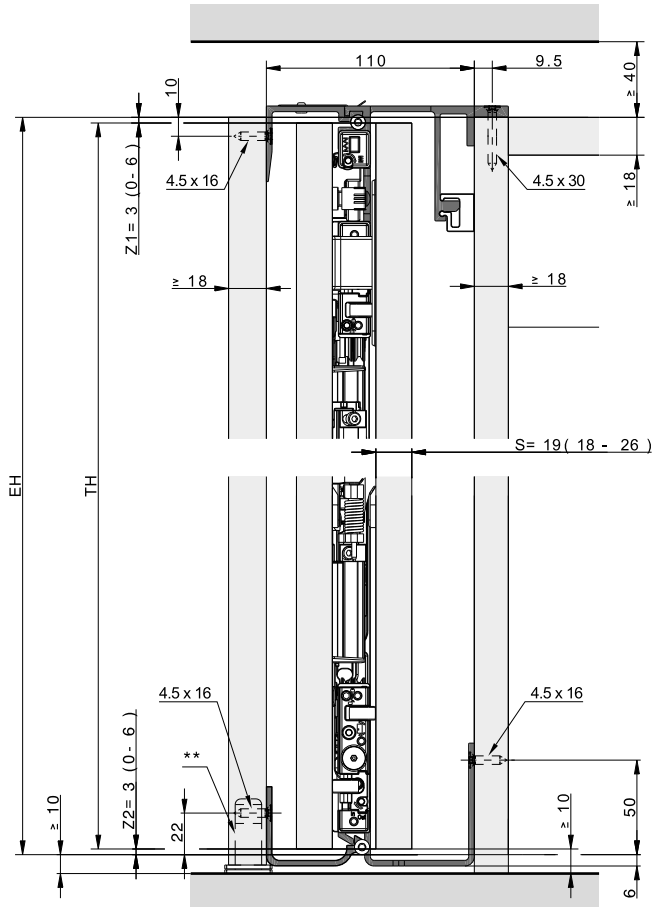

- * Verstärkungsprofil bei 3- und 4-türigen Anlagen ohne Mittelwände
- ** Empfehlung: Stellfüsse verwenden

Berechnung Beschlagtiefe

Türe bündig

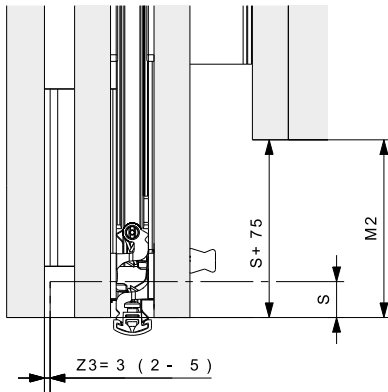

Türe vorstehend

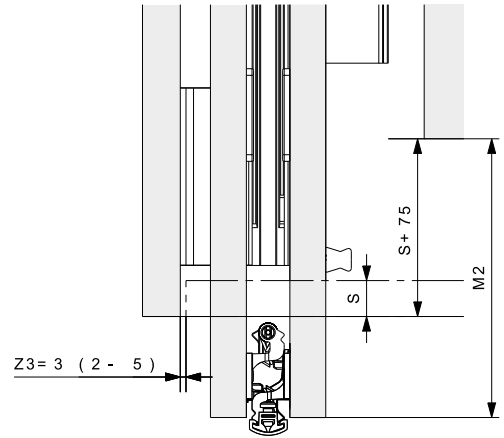

	mm
T2	$TB + 92 + Z3 - M2$
E2	$TB - M2$
KT2	$\geq T2$
M2	$\geq S + 75$ $\leq TB - 390$

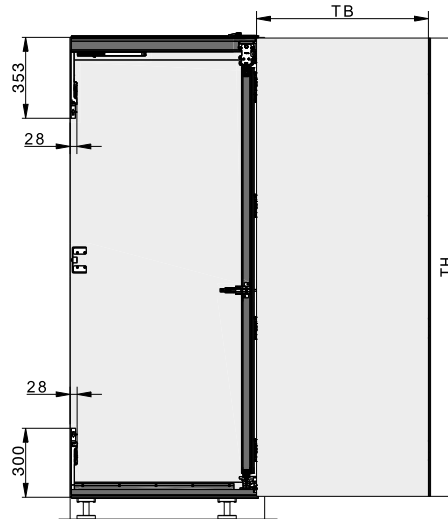
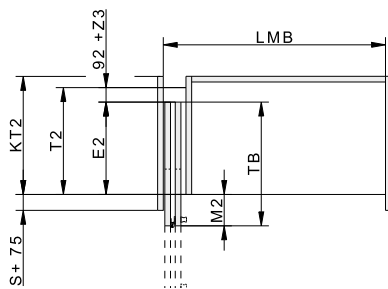

- S = Türdicke
- Z = Fugenmass
- E2 = Einschubtiefe
- T2 = Beschlagtiefe
- M2 = Türüberstand über Korpus
- TB = Türbreite
- TH = Türhöhe
- KT2 = Korpusstärke
- LMB = Lichtmassbreite

Anleitungen

Videos

Zubehör

– Ausrichtbeschlag ab Seite 315

Planung/Ausführung

Konfigurieren Sie mit nur wenigen Klicks auf www.hawa.com/konfigurator

Weitere Informationen zum Produkt finden Sie auf www.hawa.com.