







## Automatisierter Beschlag mit SMI Schnittstelle für 4 symmetrisch öffnende Holz- oder Metallläden bis 70 kg. Mit aufgeschraubter Laufschiene. Decken- oder Fenstersturzmontage.

### Produkt-Highlights

-  **Komfort** Automatisiertes System mit Schnittstelle zur Gebäudesteuerung  
Optimierte individuelle Tageslichtnutzung
-  **Produktivität** Steigerung der Energieeffizienz im Gebäude

### Technische Vorgaben

-  max. 70 kg
-  max. 3200 mm
-  650–1200 mm  
(max. Ladenfläche 3.84 m<sup>2</sup>)
-  28–40 mm

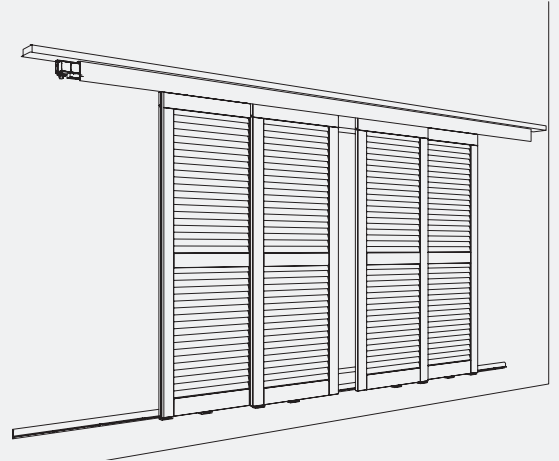



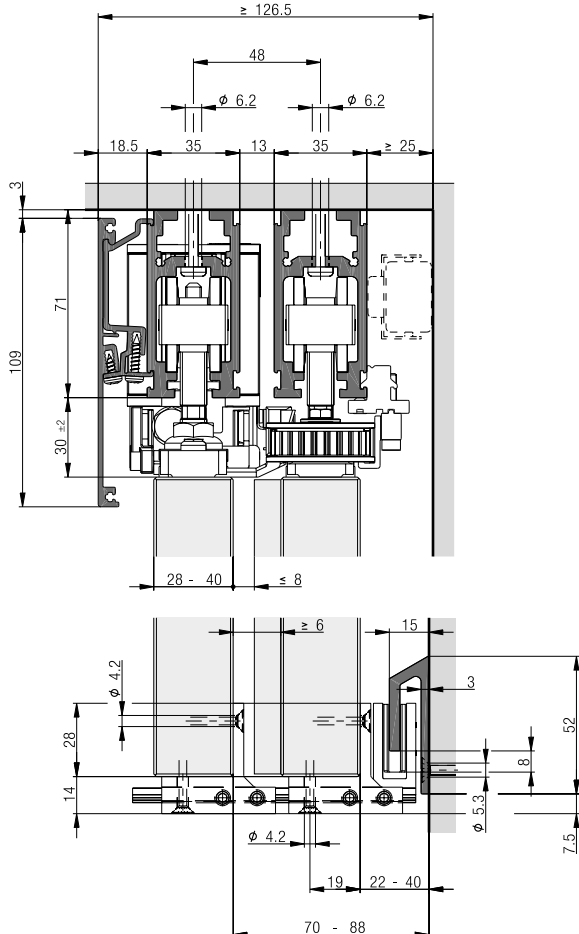





### Einbaubeispiele

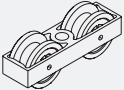
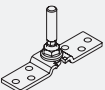
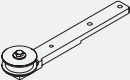
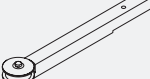

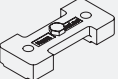
**Garnitur für 4 Schiebeläden bis 70 kg**

	Nr.
Hawa Frontslide 100 Matic Symmetric 2+2, für 4 Schiebeläden	25140





**Garnitur bestehend aus:**

	25140	Nr.
 Laufwerk, 2-rollig, M10, Kunststoffrollen	8	24552
 Aufhängebügel, Edelstahl, mit M10-Aufhängeschraube	8	24564
 Umlenkrolle, mit Befestigungsplatte, lang	1	20139
 Umlenkrolle, mit Befestigungsplatte, extralang	1	25314
 Umlenkrolle, mit Befestigungsplatte, kurz	2	20140
 Aufnahmeplatte zu Mitnehmer, breit	2	20246
 Mitnehmer für Symmetric-Anlagen	1	19655
 Mitnehmer, breit	2	20141
 Klemmstück für Zahnriemen	2	25059
 Zahnriemen, 2,7 m, glasfaserverstärkt, schwarz	1	20208
 Zahnriemen, 5 m, glasfaserverstärkt, schwarz	1	19667

**Garnitur Motronic 100 SMI**

	Nr.
Hawa Motronic 100 SMI zu Hawa Frontslide 100 Matic, inkl. Steuerung, Zahnriemenschluss und Umlenkrolle	30521

**Garnitur bestehend aus:**

	30521	Nr.
 Hawa Motronic 100 SMI mit integrierter Steuerung und Anschlusskabel inkl. vormontiertem Wieland-Stecker	1	30317
 Wieland Buchse für Hawa Motronic 60/100/140 SMI	1	30277
 Umlenkrolle zu Automat	1	24792
 Zahnriemenschluss	1	19654
 Endanschlag, Aluminium	2	24786

**Zahnriemen**

**Berechnung der Zahnriemenlänge: 2 x Anlagenbreite**

	Nr.
 Zahnriemen, 2,7 m, glasfaserverstärkt, schwarz	20208
 Zahnriemen, 5 m, glasfaserverstärkt, schwarz	19667
 Zahnriemen, 8 m, glasfaserverstärkt, schwarz	19682
 Zahnriemen, 10 m, glasfaserverstärkt, schwarz	19668
 Zahnriemen, 15 m, glasfaserverstärkt, schwarz	20370
 Zahnriemen, 50 m, glasfaserverstärkt, schwarz	19669

**Laufschienen**

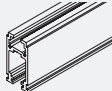
	mm	Nr.
 Laufschiene, Aluminium, eloxiert, gelocht	3500	24840
	6000	24797
	nach Mass	24798

**Verbindungsstifte zu Laufschienen**

		Nr.
	Verbindungsstifte, Set à 6 Stück	17221

**Führungsschienen**

		mm	Nr.
	Führungsschiene, Aluminium, eloxiert, gelocht	6000	24460
		nach Mass	24462

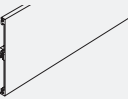

**Blenden**

		mm	Nr.
	Abdeckblende, Aluminium, eloxiert	3500	24845
		6000	24808
		nach Mass	24809
	Abdeckblende, Aluminium	6000	24810
nach Mass		24811	

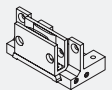
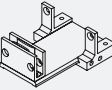

**Blendenbefestigungsteile**

		Nr.
	Blendenbefestigungsteile zu Laufschiene, mindestens alle 500 mm, Set à 5 Stück	24767

**Führungen**

		Nr.
	Führung unten, kurz, zu Führungsschiene	24543
	Führung unten, lang, zu Führungsschiene	24544
	Führungsgleiter, zum Schrauben	24542

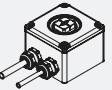
**Inbetriebnahmebox**



		Nr.
	Inbetriebnahme-Box	23789
	SMI Adapter für Inbetriebnahme-Box	30363

**Technische Daten Hawa Motronic 100 SMI**

Antrieb mit integrierter Steuerung, mit SMI 3.0 BF Schnittstelle, CE geprüft

Speisung:	100 – 240 VAC 50/60 Hz, 30 W
Max. Vorsicherung:	16 A
Überspannungskategorie:	II
Schutzklasse:	I
Temperaturbereich:	-20° C bis +60° C
Verschmutzungsgrad:	1
IP Schutzgrad:	IP 54
Max. Geschwindigkeit:	70 mm/s
Max. Antriebskraft:	100 N (intern vor Überlast geschützt)
Schalerelemente:	bauseits
Netztrenneinrichtung:	bauseits

**Typenschild**

<b>Hawa Motronic 100</b>			I- →
Artikel-Nr.	30317	<b>Hawa</b>	
Kontakt	www.hawa.com		
Charge	20ZZ/YYYYYY		
Key-ID	0016XXXXXX, Bj: 20ZZ		
Antriebskraft max.	100 N, IP54		
	100-240 VAC, 50/60 Hz, 30 W		
	Geschwindigkeit max. 7 cm/s		
	Betriebstemp. -20 °C bis +60 °C		I+ →

**Ansteuerung und Bedienung der Anlage**

Die Anlage kann mit handelsüblichen Storeschaltern bedient werden.

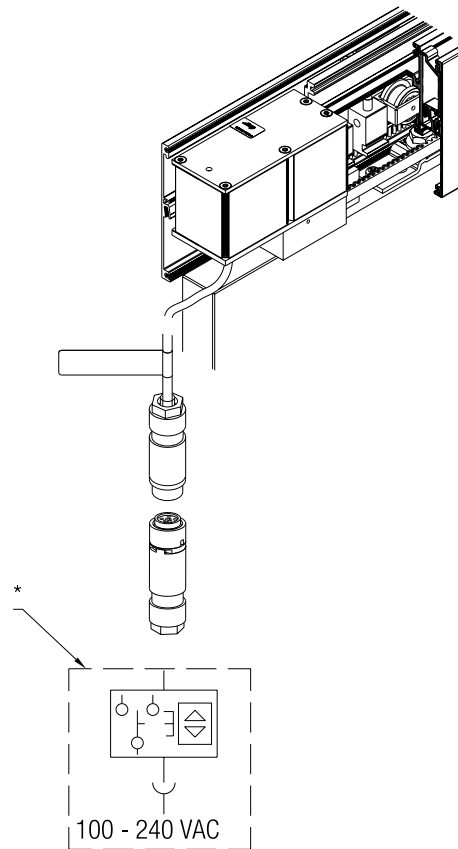

\* bauseits

**Montage Blendenbefestigungsteile**

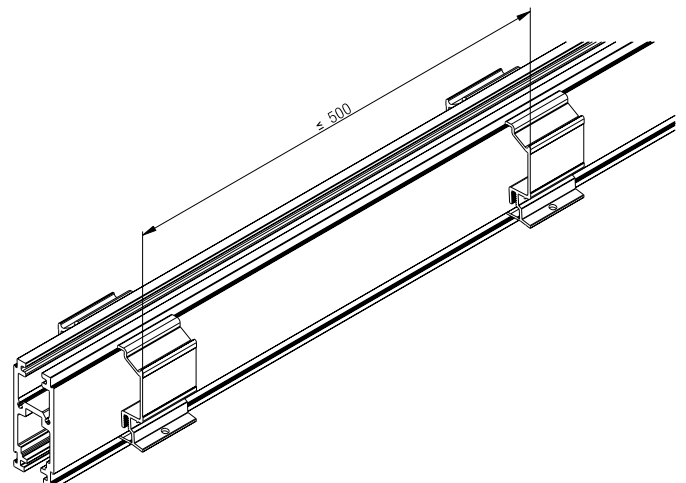

**Berechnungen Schiebeladenbreite**

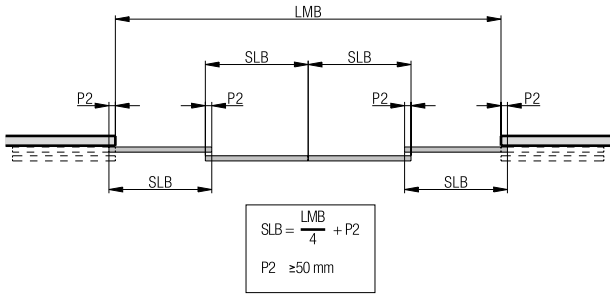

- AB = Anlagenbreite
- LMB = Lichtmassbreite
- SLB = Schiebeladenbreite
- P = Schiebeladenüberschneidung
- LS1 = innere Laufschiene
- LS2 = äussere Laufschiene
- FS = Führungsschiene
- M = minimaler Platz für Antriebseinheit

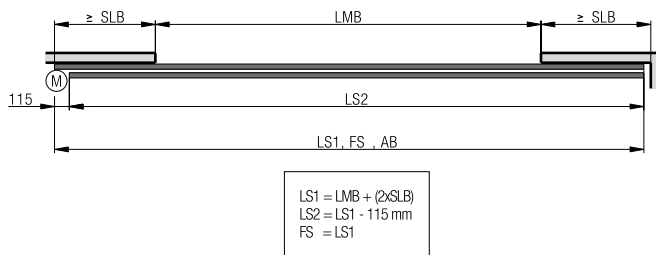

**Aufhängepunkte**

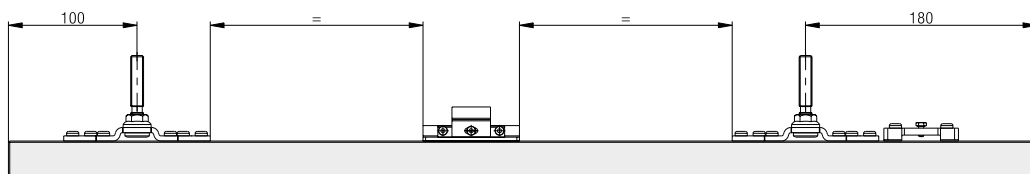
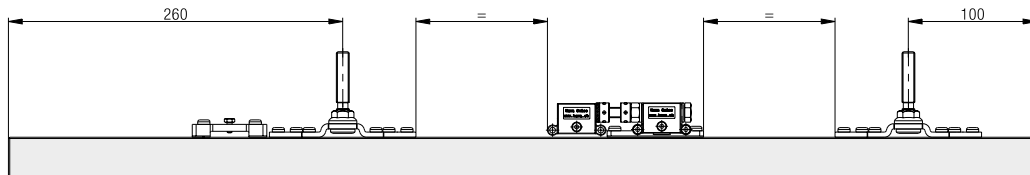

Führungen

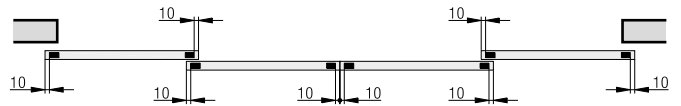
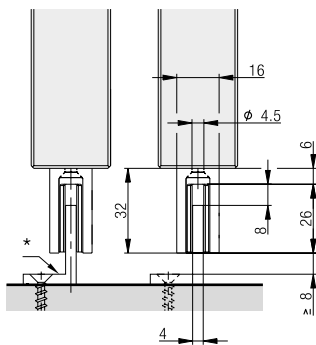
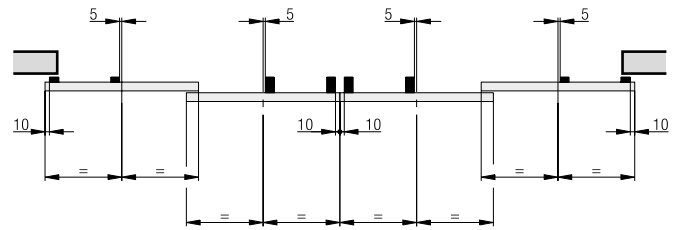
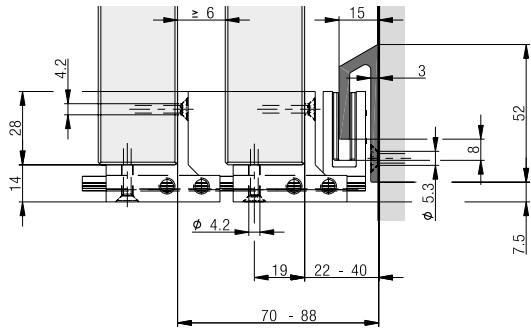

\* bauseits

Planung/Ausführung

- Korrosionsbeständigkeit Klasse 4 nach EN 1670 (sehr hohe Beständigkeit)
- Übersicht Windwiderstandsklassen ab Seite 198

Weitere Informationen zum Produkt finden Sie auf [www.hawa.com](http://www.hawa.com).