







**Beschlag für oben laufende Glastüren bis 100 kg, mit aufgesetzter Laufschiene.  
Optional mit Dämpfeinzug. Wand- oder Deckenmontage.**

**Produkt-Highlights**

-  **Flexibilität**    Wand- und Deckenmontage mit Aluminium- oder Holzblende
-  **Ästhetik**        Komplette Technik hinter schlichten Blenden verborgen

**Technische Vorgaben**

-  max.            100 kg
-  max.            2700 mm
-  max.            1600 mm
-  8–12.7 mm

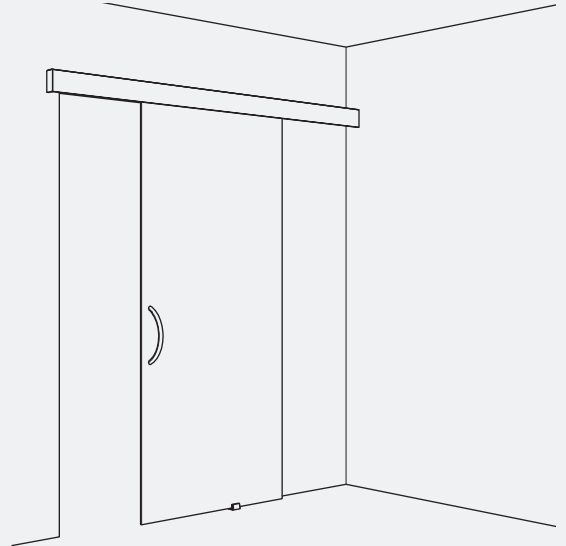

**Einbaubeispiele**

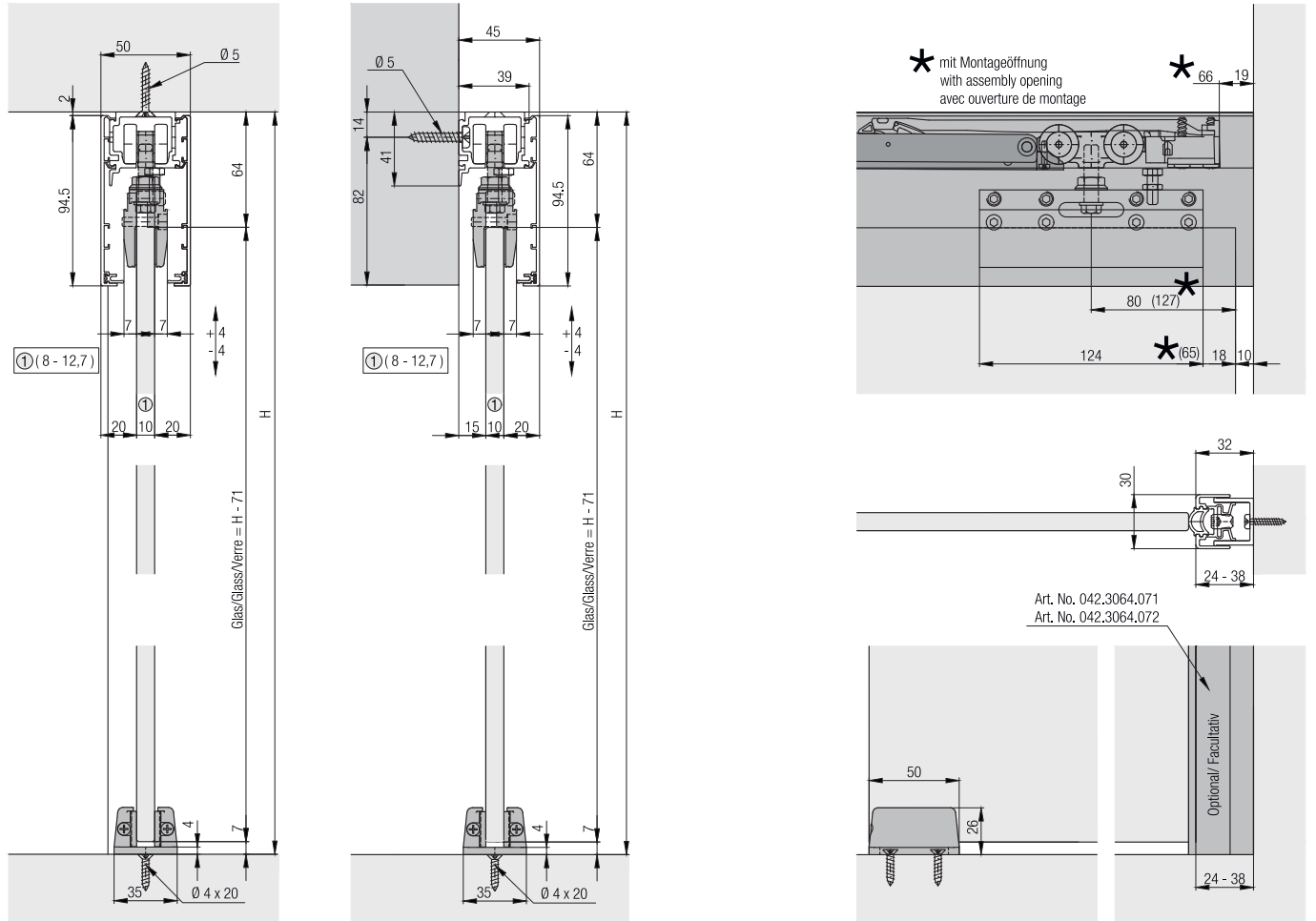

**Garnitur für Decken- oder Wandmontage,  
für 1 Glastüre bis 100 kg**

	Nr.
Hawa Porta 100 G/GU/GM/GF, für 1 Türe	057.3074.071

**Garnitur bestehend aus:**

		057.3074.071	Nr.
	Laufwerk, Kugellager, Rollen Kunststoff weiss	2	057.3114.071
	Stopper, mit Rückhaltefeder, Kunststoff, grau	1	057.3073.072
	Stopper, ohne Rückhaltefeder, Kunststoff, grau	1	057.3073.071
	Tragschraube, M8x32 mm, Stahl, verzinkt	2	057.0123.104
	Sechskant-Sperrzahn-mutter, M8, Stahl, verzinkt	2	768.9005.101
	Klemmschuh, Aluminium, Glasstärke 8-12.7 mm	2	057.3032.075
	Sechskantschraube, M6x20 mm, Kunststoff, weiss	2	762.9480.000
	Sechskantmutter, M6, Stahl, verzinkt	2	768.2001.101
	Bodenführung, spielfrei, verchromt, matt	1	057.3030.071
	Wandpuffer, 19x10 mm, Gummi, schwarz	1	024.0002.046
	Senkkopfschraube, 4x20 mm, Stahl, verzinkt	3	766.5042.120

**Laufschienen**

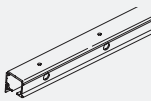
	mm	Nr.
	1'700	057.3048.170
	2'000	057.3048.200
	2'500	057.3048.250
	3'500	057.3048.350
	6'000	057.3048.600
	nach Mass	057.3048.990

**Blenden**

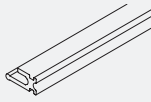

	mm	Nr.
	2'500	057.3050.250
	3'500	057.3050.350
	6'000	057.3050.600
	nach Mass	057.3050.990
	20'000	057.3078.002

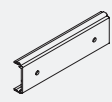
**Clip-Teile**

	Nr.
	057.3117.001

**Blendenendstück-Set, 44.5 mm, Aluminium**

	Nr.
Blendenendstück-Set, 44.5 mm, einseitig, Wandmontage, Aluminium	057.3052.074



		057.3052.074	Nr.
	Blendenendstück, 44.5 mm, Aluminium, eloxiert	1	057.3052.904
	Fixierschraube, M4x2.6 mm, Stahl, verzinkt	4	011.0101.171
	Verbindungswinkel, Stahl, verzinkt	2	057.3051.101

**Garnitur bestehend aus:**

**Blendenendstück-Set, 50 mm, Aluminium**

	Nr.
Blendenendstück-Set, 50 mm, einseitig, Deckenmontage, Aluminium	057.3052.071

**Garnitur bestehend aus:**

		057.3052.071	Nr.
	Blendenendstück, 50 mm, Aluminium, eloxiert	1	057.3052.901
	Verbindungswinkel, Stahl, verzinkt	2	057.3051.101
	Fixierschraube, M4x2.6 mm, Stahl, verzinkt	4	011.0101.171

**Dämpfeinzug**  
Bei Dämpfung in Öffnungs- und Schliessrichtung immer 2 Garnituren bestellen.

	Nr.
Dämpfeinzug Hawa Porta 60/100, Divido 100, 61-100 kg, 1 Stück	042.3102.071
Dämpfeinzug Hawa Porta 60/100, Divido 100, 10-60 kg, 1 Stück	042.3102.072

**Garnitur bestehend aus:**

		042.3102.071	042.3102.072	Nr.
	Dämpfeinzug, oben laufend, 61-100 kg, Kunststoff	1		042.3106.071
	Auslösezunge zu Dämpfung im Bau, Zinkdruckguss	1	1	042.3105.001
	Schrauben-Set	1	1	600.0000.566
	Dämpfeinzug, oben laufend, 10-60 kg, Kunststoff		1	042.3106.072

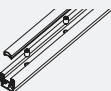

**Wandausgleichsprofile**

	mm	Nr.
	2'500	042.3064.071
	3'000	042.3064.072

**Bodenführung**  
Spielfrei einstellbar für Wandmontage

	Nr.
 Bodenführung Wandbefestigung, spielfrei einstellbar	057.3015.175

**Zubehör**

	Nr.
 Bodentürstopper, mit Zentrierteil, verchromt, matt	20773
 Schienenreiniger, Kunststoff, blau	057.3099.071

**Holzblenden**

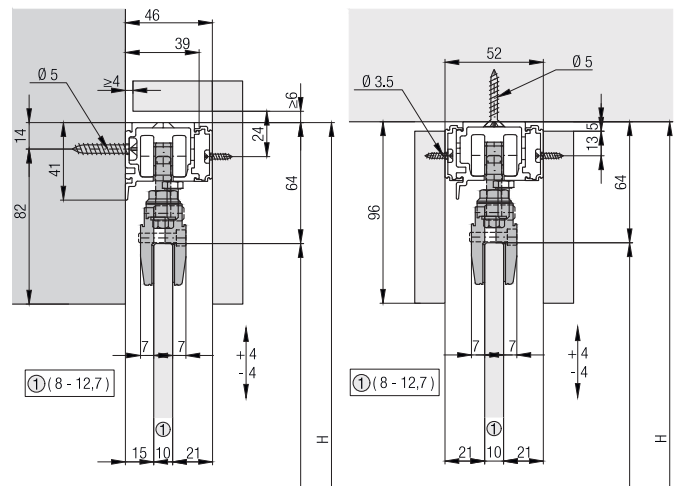

**Berechnungen Blenden**

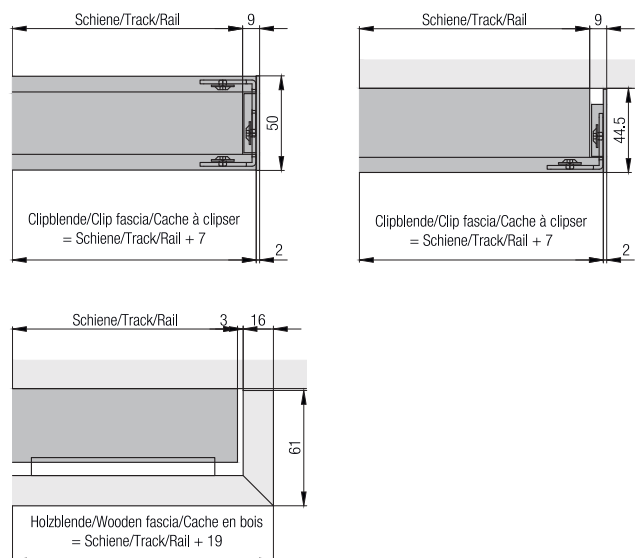

**Bodenführung spielfrei**

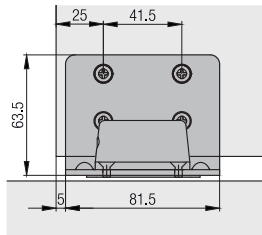
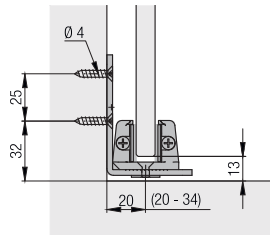

**Bodentürstopper**

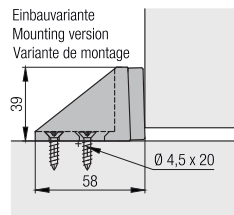

**Weitere Einbaubeispiele**

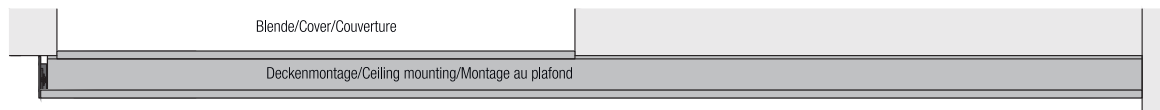

**Dämpfeinzug**

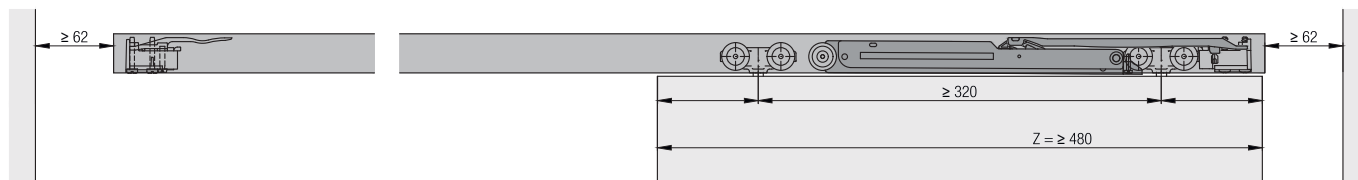

	Z =					
	1			2		
	0	1	2	0	1	2
Hawa Porta 60/100 H/HC	480	535	590	730	785	840
Hawa Porta 60/100 HM/HMD/HMT	480	535	590	730	785	840
Hawa Porta 100 G/GU/GM	480	535	590	730	785	840
Hawa Porta 100 GW/GWF	512	542	590	762	792	840
Hawa Porta 100 GMD	488	539	590	738	789	840
Hawa Divido 100 H/HM/GR	480	535	590	730	785	840
Hawa Divido 100 GRM	512	567	622	762	817	872

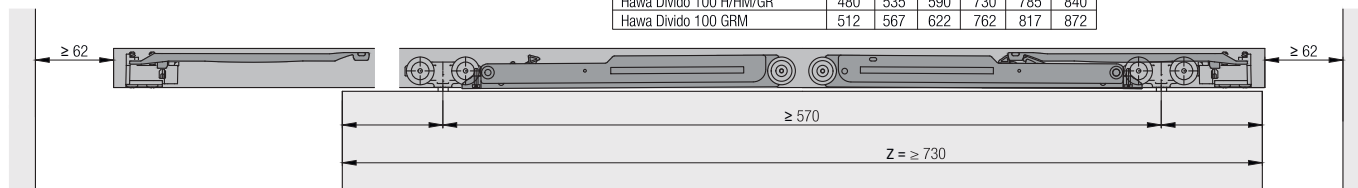

**Zubehör**

- Schlosslösungen ab Seite 362
- Allgemeines Zubehör ab Seite 371
- Glasempfehlungen ab Seite 379

**Planung/Ausführung**

Weitere Informationen zum Produkt finden Sie auf [www.hawa.com](http://www.hawa.com).