

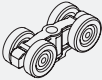

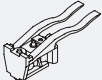







Garnitur für Deckenmontage, für 1 Glastüre bis 100 kg

	Nr.
Hawa Porta 100 GMT, für 1 Türe	057.3184.071

Garnitur bestehend aus:

		057.3184.071	Nr.
	Laufwerk, Kugellager, Rollen, Kunststoff, weiss	2	057.3114.071
	Stopper, mit Rückhaltefeder, Kunststoff, grau	1	057.3073.072
	Stopper, ohne Rückhaltefeder, Kunststoff, grau	1	057.3073.071
	Tragschraube, M8x32 mm, Stahl, verzinkt	2	057.0123.104
	Sechskant-Sperrzahn-mutter, M8, Stahl, verzinkt	2	768.9005.101
	Klemmschuh, Aluminium, Glasstärke 8–12.7 mm	2	057.3032.075
	Sechskantschraube, M6x20 mm, Kunststoff, weiss	2	762.9480.000
	Sechskantmutter, M6, Stahl, verzinkt	2	768.2001.101
	Bodenführung, spielfrei, Glasstärke 8–12.7 mm, verchromt, matt	1	057.3082.071
	Wandpuffer, 19x10 mm, Gummi, schwarz	1	024.0002.046
	Senkkopfschraube, 4x20 mm, Stahl, verzinkt	3	766.5042.120













Set für Deckenmontage, für 1 Glastüre bis 100 kg

	Nr.
Hawa Porta 100 GMT, mit Push-to-open, mit Laufschiene, 2000 mm, Aluminium, eloxiert, für 1 Türe	057.3184.072
Hawa Porta 100 GMT, mit Push-to-open, mit Laufschiene, 2500 mm, Aluminium, eloxiert, für 1 Türe	057.3184.073

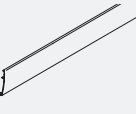

		mm	057.3184.072	057.3184.073	Nr.
	Laufwerk, Kugellager, Rollen, Kunststoff, weiss		2	2	057.3114.071
	Stopper, ohne Rückhaltefeder, Kunststoff, grau		2	2	057.3073.071
	Dämpfeinzug, oben laufend, 61-100 kg, Kunststoff		1	1	042.3106.071
	Auslösezunge zu Dämpfung im Bau, Zinkdruckguss		1	1	042.3105.001
	Push-to-open Hawa Porta 100, 40–100 kg, mit Selbsteinzug		1	1	057.3177.071
	Auslösezunge zu Push-to-open, Zinkdruckguss		1	1	057.3176.001
	Schrauben-Set		2	2	600.0000.566
	Tragschraube, M8x32 mm, Stahl, verzinkt		2	2	057.0123.104
	Sechskant-Sperrzahn-mutter, M8, Stahl, verzinkt		2	2	768.9005.101
	Klemmschuh, Aluminium, Glasstärke 8–12.7 mm		2	2	057.3032.075
	Sechskantschraube, M6x20 mm, Kunststoff, weiss		2	2	762.9480.000
	Sechskantmutter, M6, Stahl, verzinkt		2	2	768.2001.101
	Bodenführung, spielfrei, Glasstärke 8–12.7 mm, verchromt, matt		1	1	057.3082.071

Fortsetzung Tabelle auf nächster Seite

Fortsetzung Tabelle von vorheriger Seite

	Senkkopfschraube, 4x20 mm, Stahl, verzinkt	3	3	766.5042.120	
	Laufschiene, Aluminium, eloxiert, gelocht	2'000	1	057.3174.200	
	Montage-Knopf, Kunststoff, grau	9	11	057.0201.001	
	Senkkopfschraube, 5x40 mm, Stahl, verzinkt	10	12	766.3054.140	
	Endkappe, links zu Blende, Kunststoff, anthrazit	2	2	057.3059.001	
	Endkappe, rechts zu Blende, Kunststoff, anthrazit	2	2	057.3059.002	
	Endkappen-Halter, Kunststoff, anthrazit	2	2	057.0141.001	
	Clip zu Blende, Kunststoff, grau	4	4	057.3060.001	
	Zylinderschraube, M5x18 mm, Stahl, verzinkt	8	8	600.0000.661	
	Zylinderschraube, M5x20 mm, Stahl, verzinkt	8	8	763.0508.120	
	Clip-Blende, zu Klemmschuh, Aluminium, eloxiert	1'500	2	2	057.3039.150
	Laufschiene, Aluminium, eloxiert, gelocht	2'500	1	057.3174.250	

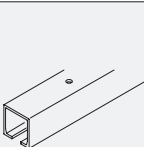
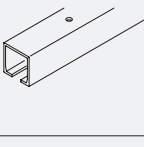
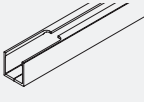
Laufschienen

		mm	Nr.
	Laufschiene, Aluminium, gelocht	1'700	057.3016.170
		2'000	057.3016.200
		2'500	057.3016.250
		6'000	057.3016.600
	nach Mass	057.3016.990	
	Laufschiene, Aluminium, eloxiert, gelocht	2'000	057.3016.201
		2'500	057.3016.251
		6'000	057.3016.601
		nach Mass	057.3016.991
	Laufschiene, mit Montageöffnung, Aluminium, eloxiert, gelocht	2'500	057.3016.256
		nach Mass	057.3016.998
	Einwegabdeckung zu Laufschiene Hawa Divido 100 / Hawa Porta 45/60/100, Kunststoff, schwarz	2'000	057.3098.001
		nach Mass	057.3098.990

Montage-Set

	Nr.
Montage-Set Hawa Porta 60/100, 2000 mm	057.3179.200
Montage-Set Hawa Porta 60/100, 2500 mm	057.3179.250
Montage-Set Hawa Porta 60/100, 3000 mm	057.3179.300

		mm	057.3179.200	057.3179.250	057.3179.300	Nr.
	Laufschiene, Aluminium, eloxiert, gelocht	2'000	1			057.3174.200
	Montage-Knopf, Kunststoff, grau	9	11	13		057.0201.001
	Senkkopfschraube, 5x40 mm, Stahl, verzinkt	10	12	14		766.3054.140
	Laufschiene, Aluminium, eloxiert, gelocht	2'500		1		057.3174.250
	Laufschiene, Aluminium, eloxiert, gelocht	3'000			1	057.3174.300



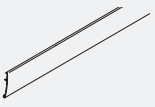



Blenden

		mm	Nr.
	Clip-Blende, zu Klemmschuh, Aluminium, eloxiert	2'500	057.3039.250
		6'000	057.3039.600
		nach Mass	057.3039.990

Endkappen-Set

		Nr.
Endkappen-Set für Blenden		057.3061.072



Garnitur bestehend aus:

		057.3061.072	Nr.
	Endkappe, links zu Blende, Kunststoff, anthrazit	2	057.3059.001
	Endkappe, rechts zu Blende, Kunststoff, anthrazit	2	057.3059.002
	Endkappen-Halter, Kunststoff, anthrazit	2	057.0141.001
	Clip zu Blende, Kunststoff, grau	4	057.3060.001
	Zylinderschraube, M5x18 mm, Stahl, verzinkt	8	600.0000.661
	Zylinderschraube, M5x20 mm, Stahl, verzinkt	8	763.0508.120

Push-to-open mit Selbsteinzug (darf nur mit Hawa Porta 100 eingesetzt werden)

		Nr.
Push-to-open Hawa Porta 100, 40–100 kg, 1 Stück		057.3178.071

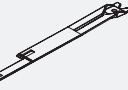

Garnitur bestehend aus:

		057.3178.071	Nr.
	Push-to-open Hawa Porta 100, 40–100 kg, mit Selbsteinzug	1	057.3177.071
	Auslösezunge zu Push-to-open, Zinkdruckguss	1	057.3176.001
	Schrauben-Set	1	600.0000.566

Dämpfeinzug Bei Dämpfung in Öffnungs- und Schliessrichtung immer 2 Garnituren bestellen.

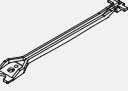

		Nr.
Dämpfeinzug Hawa Porta 60/100, Divido 100, 61–100 kg, 1 Stück		042.3102.071
Dämpfeinzug Hawa Porta 60/100, Divido 100, 10–60 kg, 1 Stück		042.3102.072

Garnitur bestehend aus:

		042.3102.071	042.3102.072	Nr.
	Dämpfeinzug, oben laufend, 61-100 kg, Kunststoff	1		042.3106.071
	Auslösezunge zu Dämpfung im Bau, Zinkdruckguss	1	1	042.3105.001
	Schrauben-Set	1	1	600.0000.566
	Dämpfeinzug, oben laufend, 10-60 kg, Kunststoff		1	042.3106.072

Abdeckung Montageöffnung

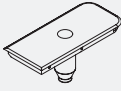
	Nr.
Abdeckkappe zu Montageöffnung, Set à 1 Stück	042.3114.071

		042.3114.071	Nr.
Garnitur bestehend aus:			
	Abdeckkappe Montageöffnung, Kunststoff, grau	1	042.0172.001
	Schrauben-Set	1	600.0000.566

Zubehör

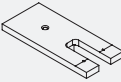
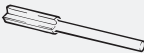
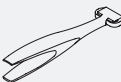
		Nr.
	Federpuffer Hawa Porta 60/100	27760
	Fräsllehre für Montageöffnung	042.3118.071
	Nutfräser zu Fräsllehre, Ø= 10 mm, Hartmetall	600.0000.309
	Schienenreiniger, Kunststoff, blau	057.3099.071

Schienenmontage Pocket

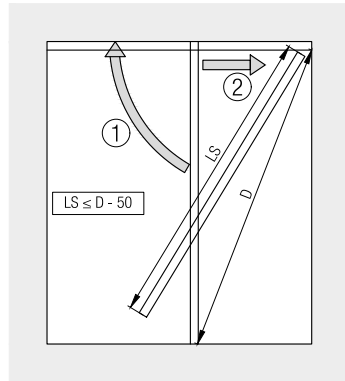
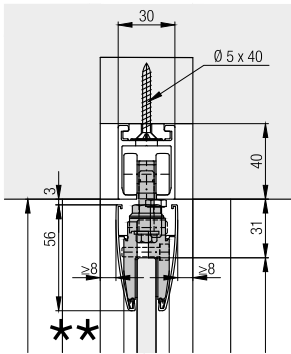

Federpuffer

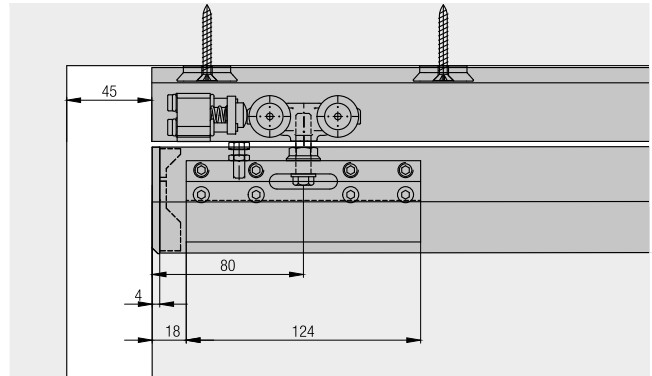

Berechnungen

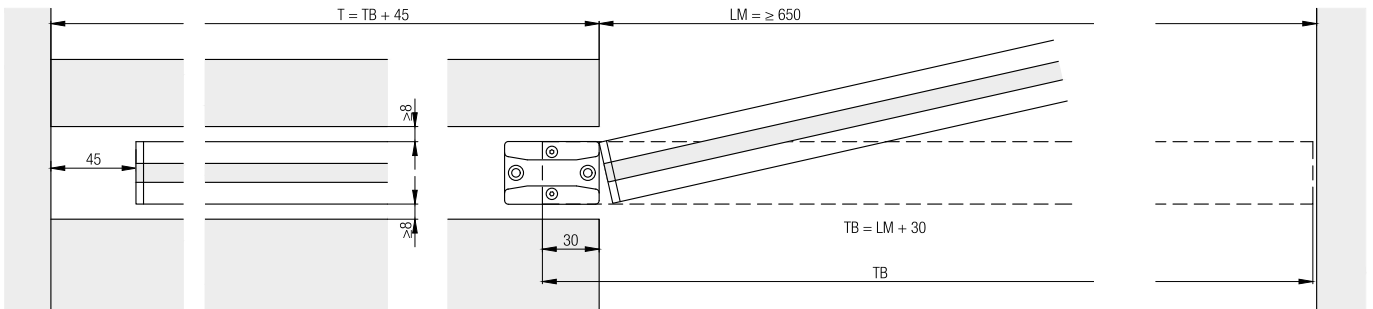

Push-to-open mit Selbsteinzug

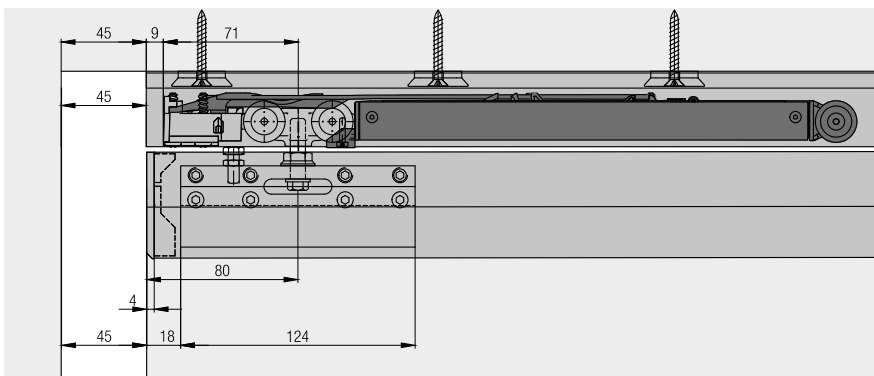

Türgewicht / door weight / poids de la porte 40-100 kg

