





## Ausrichtbeschlag zur Stabilisierung von Holztüren ab 1215 bis 2850 mm Höhe. (Für Hartholz nicht geeignet)

### Produkt-Highlights

-  **Flexibilität** Mit wählbaren Höhen und drei verschiedenen Oberflächenfarben für jede Anwendung die passende Lösung  
Das Spannprofil kann je nach Bedarf geklebt oder geschraubt werden
-  **Komfort** Stabile Konstruktion hält die Türe in Position und bleibt während der Bedienung geräuschlos

### Technische Vorgaben

-  1215–2850 mm
-  300–1600 mm
-  16–50 mm

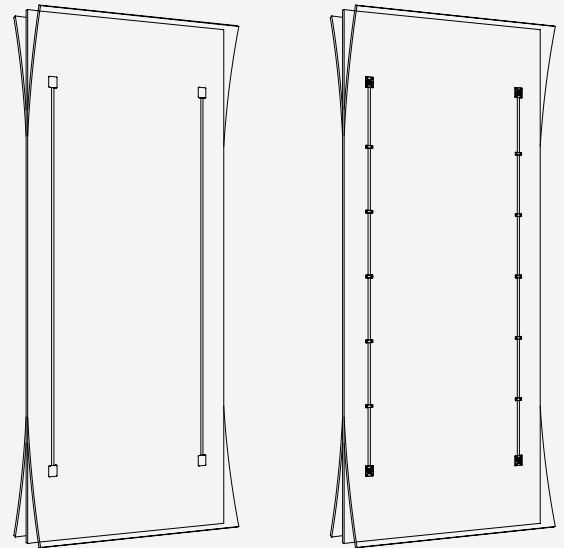



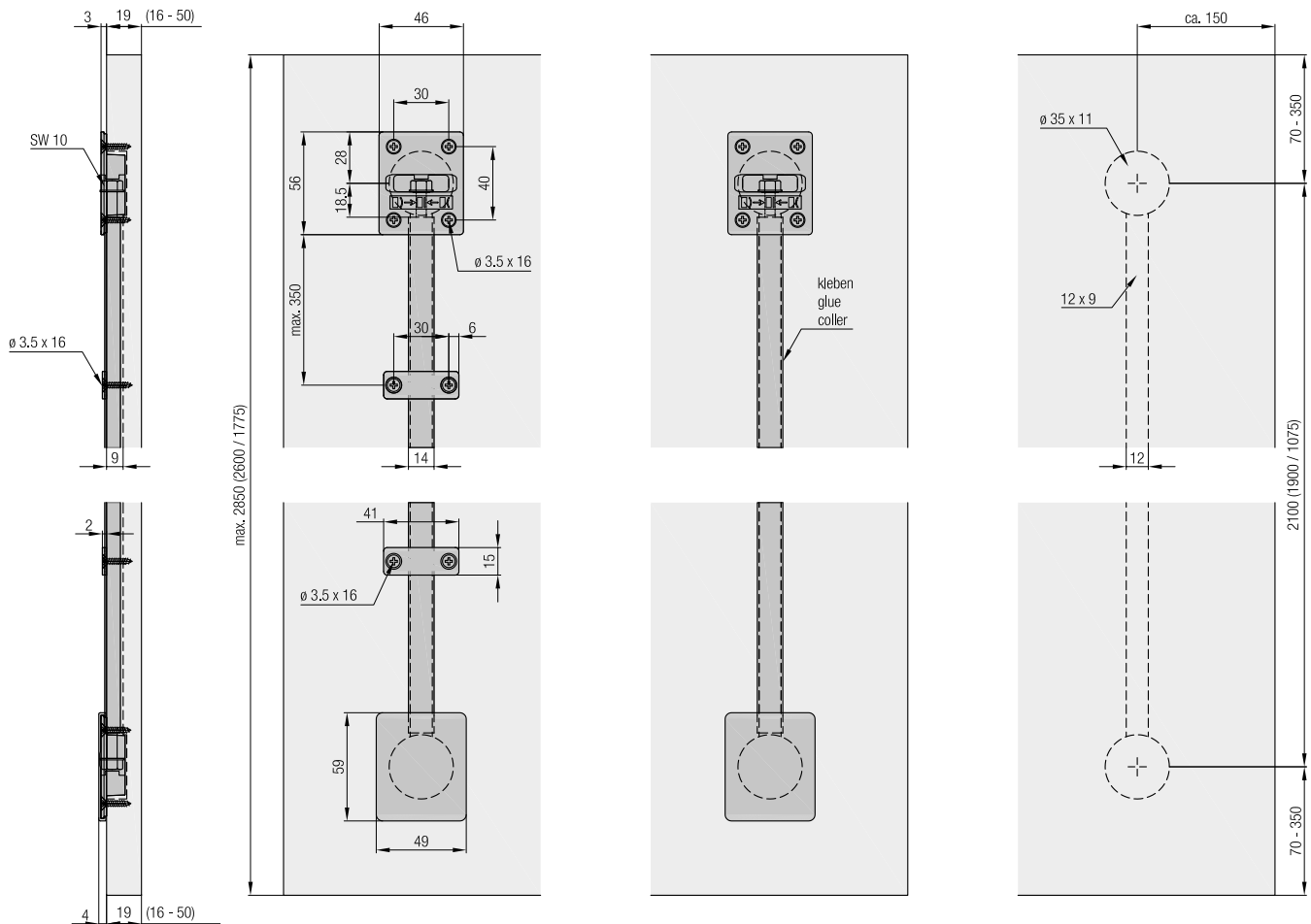



### Einbaubeispiele









## Aluminium

	Nr.
Ausrichtbeschlag für Türen 2240–2850 mm, Aluminium, eloxiert Kürzbar für Türen 1215–2240 mm	056.3192.071
Ausrichtbeschlag für Türen 2040–2600 mm, Aluminium Kürzbar für Türen 1775–2040 mm	056.3192.072
Ausrichtbeschlag für Türen 1215–1775 mm, Aluminium	056.3192.073

Garnitur bestehend aus:		mm	056.3192.071	056.3192.072	056.3192.073	Nr.
	Ankerteil, Zinkdruckguss		4			056.0199.001
	Bride, Kunststoff, schwarz		10	10	10	056.2023.001
	Gewindeschneidende Sechskant-Schraube, M6x40 mm, Stahl, verzinkt		4	4	4	056.0130.101
	Spannprofil, Aluminium, eloxiert	2063	2			056.0200.226
	Ankerteil, Kunststoff, schwarz			4	4	056.2024.001
	Spannprofil, Aluminium	1863		2		056.0200.186
	Spannprofil, Aluminium	1038			2	056.0200.103

## Aluminium, schwarz eloxiert

	Nr.
Ausrichtbeschlag für Türen 2240–2850 mm, Aluminium, eloxiert, schwarz	056.3192.074
Ausrichtbeschlag für Türen 2040–2600 mm, Aluminium, eloxiert, schwarz Kürzbar für Türen 1775–2040 mm	056.3192.075
Ausrichtbeschlag für Türen 1215–1775 mm, Aluminium, eloxiert, schwarz	056.3192.076

Garnitur bestehend aus:		mm	056.3192.074	056.3192.075	056.3192.076	Nr.
	Ankerteil, Zinkdruckguss		4			056.0199.001
	Abdeckkappe, Kunststoff, schwarz		4			056.0201.001
	Gewindeschneidende Sechskant-Schraube, M6x40 mm, Stahl, verzinkt		4	4	4	056.0130.101
	Spannprofil, Aluminium, eloxiert, schwarz	2063	2			056.0200.207
	Ankerteil, Kunststoff, schwarz			4	4	056.2024.001
	Spannprofil, Aluminium, eloxiert, schwarz	1863		2		056.0200.187
	Spannprofil, Aluminium, eloxiert, schwarz	1038			2	056.0200.104

## Zubehör

	Nr.	
	Abdeckkappe, Kunststoff, schwarz, Set à 4 Stück	056.0201.071
	Bride, Kunststoff, schwarz, Set à 10 Stück	056.0118.004

### Bestellangaben

– Typ und Anzahl Garnituren

### Bestellangaben optional

– Anzahl Abdeckkappen  
– Anzahl Briden



### Planung/Ausführung

Sämtliche Ausrichtbeschläge können auf das gewünschte Mass gekürzt werden.

Für Planung und Ausführung muss die Montageanleitung Nr. 788.2000.314 verwendet werden. Weitere Informationen zum Produkt finden Sie auf [www.hawa.com](http://www.hawa.com).



# Zubehör

## Griffprofile

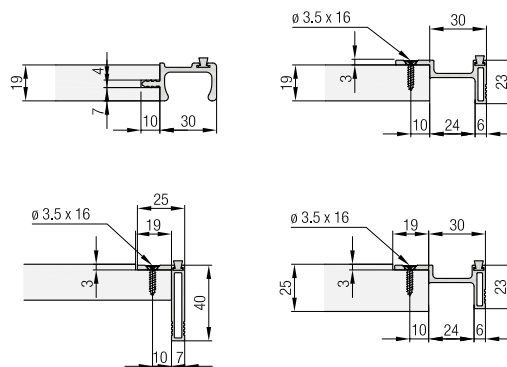
		mm	Nr.
	Griffprofil, Nut für Bürstendichtung, Aluminium, eloxiert, zum Schrauben	2500	055.3141.250
		6000	055.3141.600
	Griffprofil, Nut für Bürstendichtung, Aluminium, eloxiert, zum Einnuten	2500	056.3028.250
		6000	056.3028.600
	Griffprofil, Nut für Bürstendichtung, Aluminium, eloxiert, zum Schrauben	2500	055.3140.250
		6000	055.3140.600
	Bürstendichtung, in Rollen, grau	10000	053.3040.100



**Einzelteile Hawa Combino 20**

		Nr.
	Winkelaufwerk, Hawa Combino 20, mit Gleitlager	056.3007.172
	Winkelaufwerk, Hawa Combino 20, mit Kugellager	056.3007.171
	Clip-Teil, für Holzblende, alle 500 mm, Aluminium, gelocht	056.3039.001

**Laufschienen**

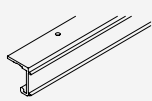
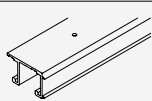
		mm	Nr.
	Einfachlaufschiene, Aluminium, gelocht	2500	056.3011.250
		3500	056.3011.350
		6000	056.3011.600
	Doppellaufschiene, Aluminium, gelocht	2500	056.3010.250
		3500	056.3010.350
		6000	056.3010.600

**Blenden**

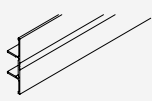
		mm	Nr.
	Clip-Blende, Aluminium, eloxiert	2500	056.3174.250
		3500	056.3174.350
		6000	056.3174.600

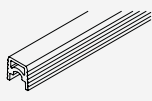

**Führungsschienen**

		mm	Nr.
	Führungsschiene, Kunststoff, grau, zum Kleben	2500	055.3171.250
		3500	055.3171.350
		6000	055.3171.600

**Bodenführung**

		Nr.
	Bodenführung, Kunststoff, grau	055.3081.071

**Einzelteile Hawa Combino 60**

		Nr.
	Winkelaufwerk, Hawa Combino 60, mit Kugellager	055.3004.171
	Clip-Teil, für Holzblende, alle 700–800 mm, Aluminium, gelocht	055.3084.001

**Laufschienen**

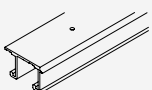
		mm	Nr.
	Einfachlaufschiene, Aluminium, gelocht	6000	055.3001.600
	Doppellaufschiene, Aluminium, gelocht	6000	055.3000.600

**Führungsschienen**

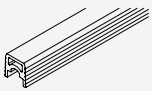
		mm	Nr.
	Führungsschiene, Kunststoff, grau, zum Kleben	2500	055.3171.250
		3500	055.3171.350
		6000	055.3171.600

**Bodenführung**

		Nr.
	Bodenführung, Kunststoff, grau	055.3081.071