

DE Vorderansicht
FR Vue de face
EN Front view
IT Vista frontale
ES Vista frontal

DE Ablängen der Profile
FR Raccourcir les profilés
EN Cutting the profiles to length
IT Taglio a misura dei profili
ES Cortar a medida los perfiles

DE Seitenansicht
FR Vue de côté
EN Side view
IT Vista laterale
ES Vista lateral

DE Draufsicht
FR Vue de dessus
EN Top view
IT Vista dall'alto
ES Vista superior

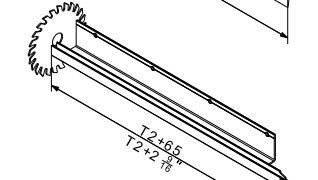
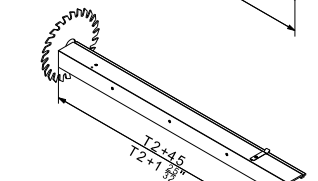
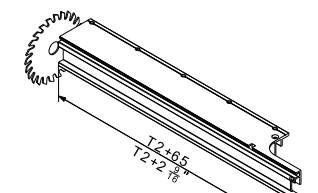
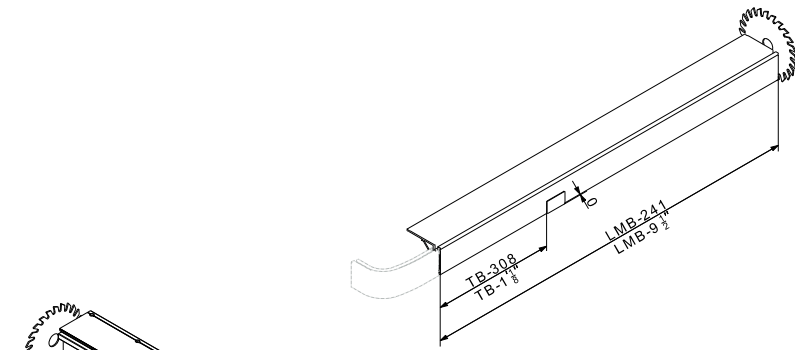
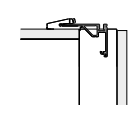
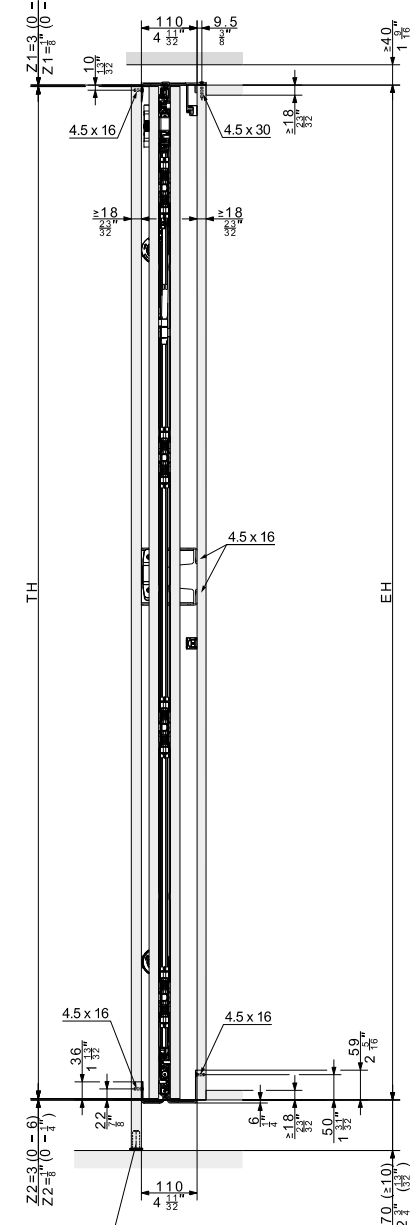

DE ohne Möbelboden
FR Sans fond
EN without base panel
IT senza fondo del mobile
ES sin base

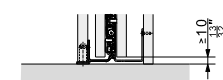

DE mit Bodenprofil, siehe Beipackblatt 52036
FR Avec profil de fond inférieur, voir le mode d'emploi joint 52036
EN with base profile, see leaflet 52036
IT con profilo a pavimento, vedere manuale di istruzioni 52036
ES con perfil para la base: ver hoja de instrucciones 52036

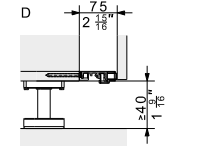

DE Empfehlung: Stellfuß verwenden
FR Recommendation: utiliser un pied de réglage
EN Recommendation: Use adjustable foot
IT Raccomandazione: Utilizzare un piedino regolabile
ES Recomendación: Utilizar un pie ajustable

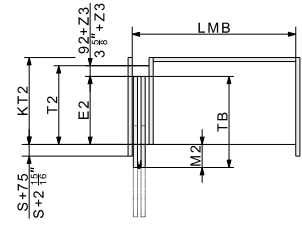
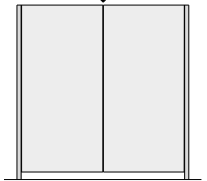

	mm	Inch
E2	TB + 92 + Z3 - M2	TB + 3 5/8" + Z3 - M2
EH	TB - M2	TB - M2
KT2	≥ T2	≥ T2
M2	≥ S + 75 ≤ TB - 390	≥ S + 2 11/16" ≤ TB - 1'3 1/2"

	mm	Inch
S	18 - 26	3/4" - 1 1/8"
T2	≥ 344	≥ 1'1 1/2"
TB	440 - 750	1'5 5/16" - 2'5 17/32"
TH (III 20)	1200 - 2200	3'11 1/4" - 7'2 5/8"
TH (III 25)	1900 - 2700	6'2 1/8" - 8'10 5/16"
Z1	0 - 6	0 - 1/4"
Z2	0 - 6	0 - 1/4"
Z3	2 - 5	3/32" - 3/16"
Z4	2 - 5	3/32" - 3/16"
Z5	2 - 5	3/32" - 3/16"

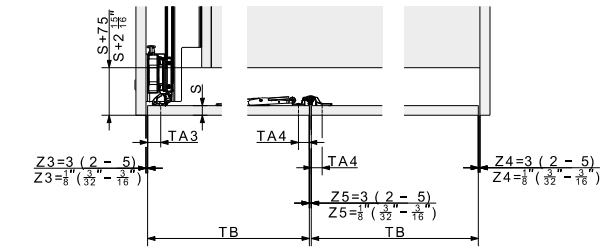
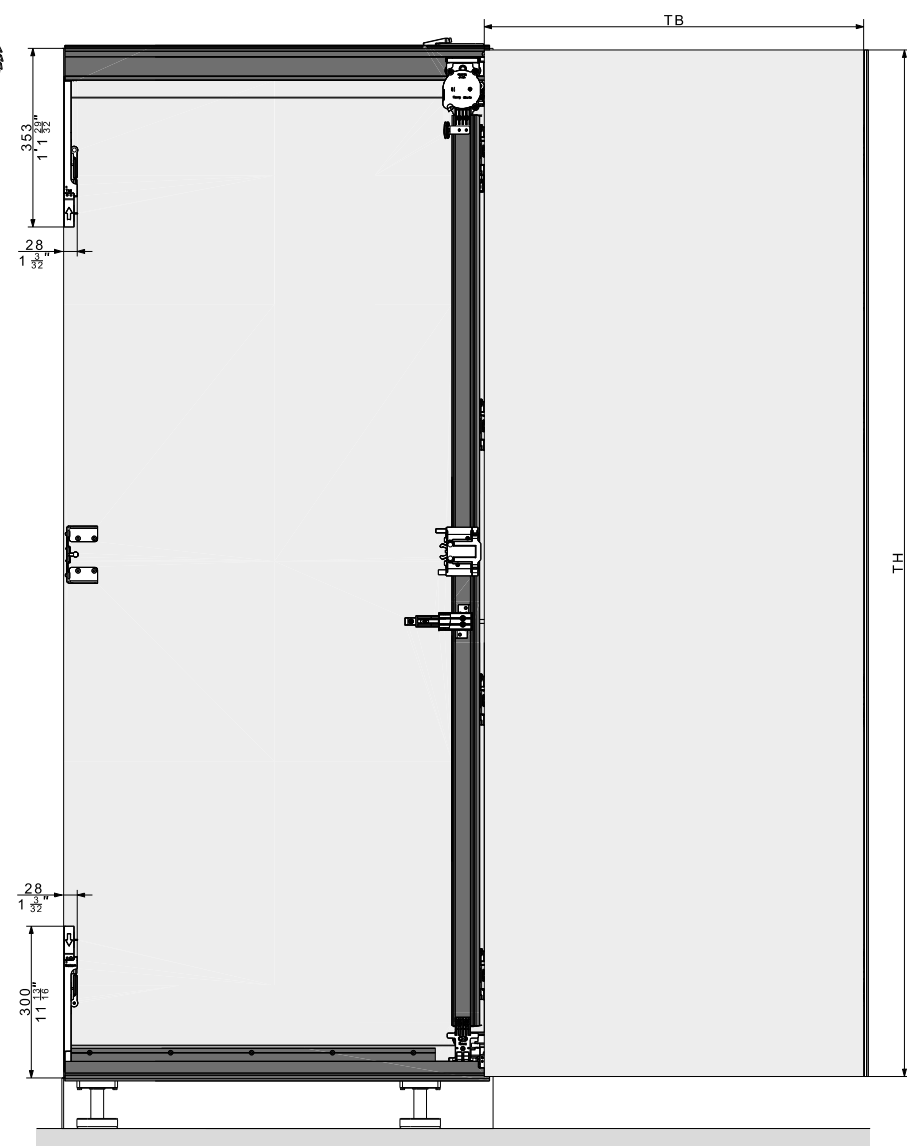

Z3	TA3	Z5	TA4
2 mm (3/32")	29 mm (1 1/8")	2 mm (3/32")	22.5 mm (7/8")
3 mm (1/8")	28 mm (1 1/8")	3 mm (1/8")	22 mm (7/8")
4 mm (5/32")	27 mm (1 1/8")	4 mm (5/32")	21.5 mm (7/8")
5 mm (3/16")	26 mm (1 1/8")	5 mm (3/16")	21 mm (7/8")

DE Türe vorstehend
FR Porte en saillie
EN Protruding door
IT Porta sporgente
ES Puerta saliente

DE Türe bündig
FR Porte affleurante
EN Flush door
IT Porta complanare
ES Puerta enrasada

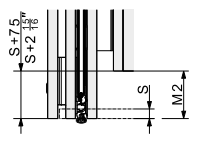
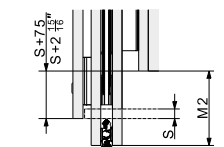

DE Abkürzungen / FR Abréviations / EN Abbreviations / IT Abbreviazioni / ES Abreviaturas

DE	FR	EN	IT	ES
E2	Profondeur d'encastrement	Slide-in depth	Profondità di inserimento	Profundidad de introducción
EH	Hauteur d'encastrement	Installation height	Altezza d'incasso	Altura de montaje
S	Profondeur de corps	Cabinet depth	Profondità mobile	Profundidad del mueble
KT2	Largueur intérieure	Inside clearance	Larghezza luce	Ancho interior
LMB	Lichtmassebreite	Door projection over cabinet	Sporgenza anta sopra il mobile	Solape de la puerta sobre el cuerpo
M2	Türüberstand über Korpus	Door thickness	Grosor de la puerta	Spessore anta
S	Türdicke	Door thickness	Grosor de la puerta	Spessore anta
T2	Beschlagtiefe	Hardware depth	Profondità ferramenta	Profundidad del herraje
TA	Topfachsabstand	Axis-centre distance of concealed hinge	Distanza scotolina asse	Distancia de la cazoleta
TB	Türbreite	Door width	Larghezza anta	Ancho de puerta
TH	Türhöhe	Door height	Altezza anta	Altura de puerta
Z	Luftzwischenraum	Air gap	Traferro d'aria	Espacio libre

DE Hawa Folding Concepta III Push 2-türig links
FR Hawa Folding Concepta III Push 2 portes, à gauche
EN Hawa Folding Concepta III Push 2 doors, left
IT Hawa Folding Concepta III Push 2 ante, a sinistra
ES Hawa Folding Concepta III Push 2 puertas izquierda

