

**Hardware system for all-glass concertina walls up to 80 kg (176 lbs.).**

**Description**

With all-glass concertina-wall installations, the suspension point is in the centre of the panel, which means that up to 6½ panels may be installed without the need for a bottom guide. An access door equipped with our top pivot may also be added on the opposite side to the folding stack. All mechanisms, suspension devices, guides and locks are fully integrated into highly attractive suspension and glass retainer profiles, and our newly developed hinge is installed on the side of the profile. The suspension and glass retainer profiles are the same ones used for Hawa Variotec 150 GV stacking-wall system. Attached to every other panel is a folding-/pivot door catch with an integrated, individually adjustable retainer, to hold the folding wall flush when closed. Our documentation simplifies the task of planning such systems, and installation is also simple and convenient.

**Applications**

This hardware system is ideal for use wherever a room needs to be divided using a high-quality glass concertina wall that is also simple to operate, e.g. in shopping centres, airports, hotels, restaurants, banks, etc.

**Features of the Hawa Centerfold 80 GV**

- Min. panel width 500 mm (1'7 11/16")
- Max. panel width 900 mm (2'11 7/16")
- Max. panel height 2600 mm (8'6 3/8")
- Max. panel weight 80 kg (176 lbs.)
- The same components may be used for constructing installations that open to the left or right, inwards or outwards
- The opposite side may be equipped with a separate pivot door
- Vertical adjustment ± 3 mm (± 1/8")
- Elegant design
- Secure locking mechanism
- Extremely smooth and silent operation
- Minimal space requirement in staking area
- Glass thickness fixed glass  
ESG (fully tempered monolithic glass): 10/12/12,7 mm (13/32/15/32/1/2")  
VSG (fully tempered laminated glass): 10,8–13 mm (7/16–17/32")

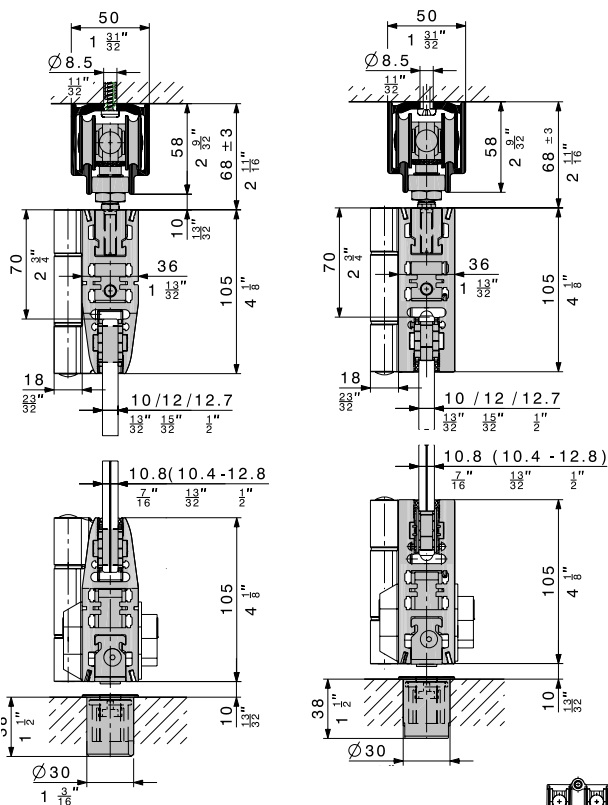
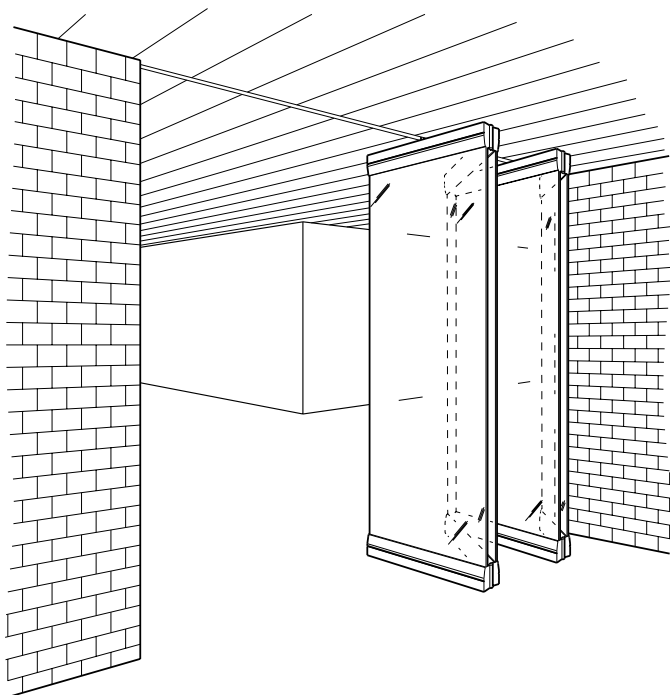

Z ≥ 5 mm (3/16")  
Clearance between wall and door

**Folding-/pivot door catch**

Every other panel has a folding-/pivot door catch (20426). Panels can thus be held flush in position without operating a locking mechanism.

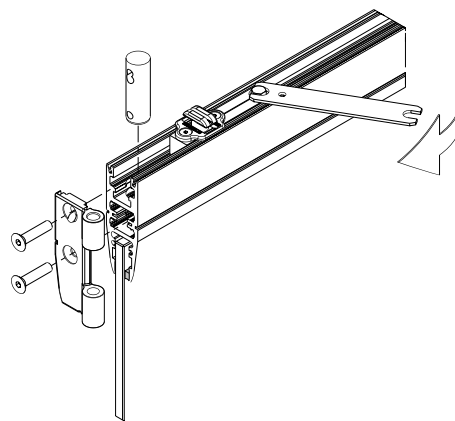

Subject to modification. Metric specifications are exact. Inches are approximate.

**Partial sets without running track and bottom guide channel**

		code
	Set for 1½ panel	16786
	Set for 1½ panel unit with pivot panel	16787
	Set for 2½ panels	16788
	Set for 2½ panel unit with pivot panel	16789
	Set for 3½ panels	16790
	Set for 3½ panel unit with pivot panel	16791
	Set for 4½ panels	16792
	Set for 4½ panel unit with pivot panel	16793
	Set for 5½ panels	16794
	Set for 5½ panel unit with pivot panel	16795

In principle, Hawa Centerfold systems may be installed without the need for a bottom guide channel.

**Running tracks**

Caution: Hole positions vary		mm/inch	code
	Running track, alu plain, anodized, predrilled	6000 (19'8 <sup>3/8</sup> " )	16852
		cut to size	16853

**Bottom guide channels**

Caution: Hole positions vary		mm/inch	code
	Bottom guide channel, alu plain anodized, predrilled, 31 x 28 mm (1 <sup>1/8</sup> " x 1 <sup>1/8</sup> " )	6000 (19'8 <sup>3/8</sup> " )	13688
		cut to size	13690

**Glass suspension and retainer profiles**





		mm/inch	code
	Glass suspension retainer profile, alu plain, anodized, brushed	6500 (21'3 <sup>3/8</sup> " )	16669
		cut to size	19868
	Glass suspension retainer profile, alu, unanodized	6500 (21'3 <sup>3/8</sup> " )	13576
		cut to size	13681
	Glass suspension retainer profile, alu plain, anodized, brushed (straight profile)	6500 (21'3 <sup>3/8</sup> " )	23440
		cut to size	23443

**Partial sets comprising**

		16786	16787	16788	16789	16790	16791	16792	16793	16794	16795	code
	Four-wheeled trolley, M10, with plastic wheels	1	1	1	1	1	1	1	1	1	1	16482
	Four-wheeled trolley, M10, with plastic wheels and spacer	-	-	-	-	1	1	1	1	2	2	16685
	Top pivot bearing	1	2	1	2	1	2	1	2	1	2	16485
	Vertically adjustable driver for pivot door	1	2	1	2	1	2	1	2	1	2	16325
	End stop	-	-	1	1	-	-	1	1	-	-	16701
	Folding-/pivot door catch, adjustable	1	2	2	3	2	3	3	4	3	4	20426
	Hawa bar bolt lock, square/hexagon socket 7/8 mm, complete with pivot	-	1	-	2	1	3	2	4	3	5	16968
	Vertical adjustment key SW 19	1	1	1	1	1	1	1	1	1	1	10789
	Suspension assembly locking wrench SW 10/11	1	1	1	1	1	1	1	1	1	1	14861
	Fork spanner SW 22/12, pivot door vertical adjustment	1	1	1	1	1	1	1	1	1	1	15409

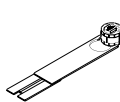
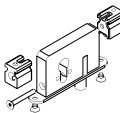
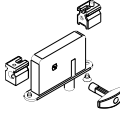
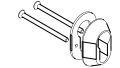
Subject to modification. Metric specifications are exact. Inches are approximate.

**Components**

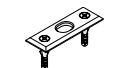
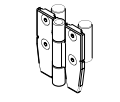
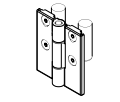
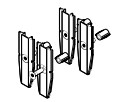
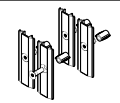
			code
	Set of glass-fixing parts, for 1 sliding door (4 pieces)	ESG <sup>1</sup> 10 mm ( $\frac{13}{32}$ "	13900
		ESG <sup>1</sup> 12 mm ( $\frac{15}{32}$ "	13901
		ESG <sup>1</sup> 12,7 mm ( $\frac{1}{2}$ "	13902
		VSG <sup>2</sup> 2 x 5 mm ( $2 \times \frac{7}{32}$ "	21263
		VSG <sup>2</sup> 2 x 6 mm ( $2 \times \frac{1}{4}$ "	23542
	Hawa bar bolt lock with retention pin	profile cylinder 17 mm ( $\frac{11}{16}$ "	16760
		round cylinder 22 mm ( $\frac{7}{8}$ "	16761
	Hawa bar bolt lock, square/hexagon socket 7/8 mm, complete with pivot		16968
	Security rose 12 mm ( $\frac{15}{32}$ "		14147
	Floor-mounted sleeve with oblong hole and chromium-plated brass spring		13787
	Rosette for floor-mounted sleeve 13787		17326
	Thrust bearing sleeve, Ø 30 mm ( $1\frac{3}{16}$ "		16326
	Thrust bearing, adjustable, Inox, for fitting into bottom guide channel		22299
	Strike plate, chromium-plated steel		13130
	Hinge, zinc alloy, with fixing screws	dull chromium finish	16091
		raw	16088
	Hinge, zinc alloy, with fixing screws (straight profile)	dull chromium finish	25976
	Cover caps, zinc alloy, set of 4 pieces	dull chromium finish	16692
		raw	16693
	Cover caps, zinc alloy, set of 4 pieces (straight profile)	dull chromium finish	25982

**Glass cutouts for sliding door**

Both glass ESG (fully tempered monolithic glass) and VSG (fully tempered laminated glass) can be used.



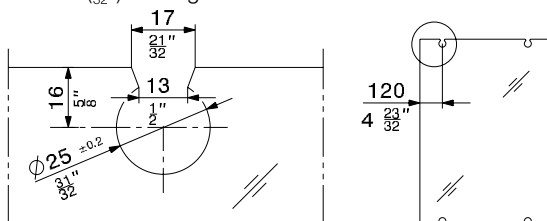

- Glass thickness sliding door ESG (fully tempered monolithic glass): 10/12/12,7 mm ( $\frac{13}{32}/\frac{15}{32}/\frac{1}{2}$ "), thickness tolerance  $\pm 0,3$  mm
- Glass thickness sliding door VSG (fully tempered laminated glass): 2x5  $\pm 0,2$  mm  $\rightarrow$  film thickness 0,76/1,52 mm  
2x6  $\pm 0,2$  mm  $\rightarrow$  film thickness 0,38/0,76 mm
- All glass edges are seamed; maximum 1 mm ( $\frac{1}{16}$ " in the glass cutout
- VSG (fully tempered laminated glass) permissible with max. offset of 2 mm ( $\frac{3}{32}$ " in the glass cutout

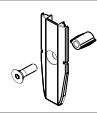
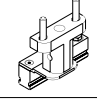
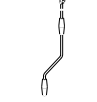
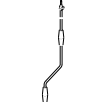
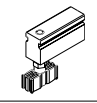

<sup>1</sup>fully tempered monolithic glass

<sup>2</sup>fully tempered laminated glass

**Accessories**

			code
	Cover cap (1 piece)	dull chromium finish	16690
		raw	16691
	Additional top lock		16491
	Short connecting rod for door height up to 2500 mm ( $8'2\frac{7}{16}$ "		14164
	Long connecting rod for door height over 2500 mm ( $8'2\frac{7}{16}$ "		14165
	Guide with plastic slider, rattle proof, 14 mm ( $\frac{9}{16}$ "		13781
	Brush seal 2,6/18 x 920 mm ( $\frac{1}{8}"/\frac{308}{32} \times 3'\frac{7}{32}$ "		16797
	Fork spanner to glass holder insert		13817
	Installation tool for blocking keys 10–12,7 mm ( $\frac{13}{32}$ " – $\frac{1}{2}$ "		13710
	Drilling jig, for hinge retention bolts		16979

**Additional top lock and services**

Details:  $\rightarrow$  Hawa Variofold 80 GV

**Order specifications**

- Quantity and type of sets
- Length of running track
- Length of bottom guide channel
- Width and height of glass
- Thickness of glass
- Quantity and type of cover caps
- Quantity and type of bottom guides
- Layout sketch

**Optional order specifications**

- Quantity of additional top lock
- Quantity and type of connecting rod
- Quantity of drilling jig, for hinge retention bolts
- Quantity and type of tool for glazing
- Quantity of brush profile

**Planning/installation**

For planning and installation purposes, please use the installation drawing code 16825.

( $\rightarrow$  [www.hawa.ch](http://www.hawa.ch)  $\rightarrow$  Hawa Productfinder)

Subject to modification. Metric specifications are exact. Inches are approximate.

<input type="checkbox"/> Offer	<input type="checkbox"/> Order	Delivery address
Customer	Object	Customer
Address	City	Address
Telephon / Telefax	Date	City
Delivery date	Professional worker	Telephon / Telefax

**Maximum panel width 900 mm (2'11<sup>11/16</sup>"), maximum panel weight 80 kg (176 lbs.)**

**Please copy this form, fill it out and mail or fax it to Hawa AG (fax no. +41 44 787 17 18)**

Sets without running track and bottom guide channel	<input type="checkbox"/> 16786	<input type="checkbox"/> 16787	<input type="checkbox"/> 16788	<input type="checkbox"/> 16789	<input type="checkbox"/> 16790	<input type="checkbox"/> 16791	<input type="checkbox"/> 16792	<input type="checkbox"/> 16793	<input type="checkbox"/> 16794	<input type="checkbox"/> 16795
	1½	1½ + 1	2½	2½ + 1	3½	3½ + 1	4½	4½ + 1	5½	5½ + 1
	Maximum widths of folding partitions									
	1400	2300	2300	3200	3200	4100	4100	5000	5000	5900
Necessary components	In principle, Centerfold systems may be installed without the need for a bottom guide channel.									
Glass thickness/glass attachment components <input type="checkbox"/> 10 mm (3/8") 13900 <input type="checkbox"/> 12 mm (1/2") 13901 <input type="checkbox"/> 12,7 mm (1/2") 13902	2	3	3	4	4	5	5	6	6	7
Lock for access <input type="checkbox"/> cyl. 17 mm (5/8") 16760 <input type="checkbox"/> cyl. 22 mm (7/8") 16761 <input type="checkbox"/> 4/6-sided nut 16968	1	1	2	1	2	1	2	1	2	1
Security rose <input type="checkbox"/> cyl. 17 mm (5/8") Security rose for standard profile cylinders 22 mm (7/8") 14147	1	1	2	1	2	1	2	1	2	1
Locking device <input type="checkbox"/> floor-mounted sleeve 13787 <input type="checkbox"/> strike plate 13130	1	2	2	3	3	4	4	5	5	6
Hinge <input type="checkbox"/> dull chromium finish 16091/25976 <input type="checkbox"/> raw 16088	2	2	4	4	6	6	8	8	10	10
Thrust bearing <input type="checkbox"/> Thrust bearing 16326 <input type="checkbox"/> Thrust bearing, adjust. 22299	1	2	1	2	1	2	1	2	1	2
Cover caps, set of 4 pieces <input type="checkbox"/> dull chromium finish 16692/25982 <input type="checkbox"/> raw 16693	1	2	1	2	1	2	1	2	1	2
Clear dimension..... mm										

**Optional accessories**

<input type="checkbox"/> Additional lock at top 16491	1	2	2	3	2	3	3	4	3	4
Connecting rod, for door height <input type="checkbox"/> up to 2500 mm (8'2 <sup>7/16</sup> ") 14164 <input type="checkbox"/> over 2500 mm (8'2 <sup>7/16</sup> ") 14165	1	1	1	1	1	1	1	1	1	1
<input type="checkbox"/> Brush seal 2,6/18 x 920 mm (1 <sup>1/8</sup> " / 3/8" x 3'4 <sup>1/2</sup> ") 16797	3	5	5	7	7	9	9	11	11	13
Tools for glazing <input type="checkbox"/> Forkspanner 13817 <input type="checkbox"/> Installation tool 13710	1	1	1	1	1	1	1	1	1	1
<input type="checkbox"/> Drilling jig, for hinge retention bolts 16979	1	1	1	1	1	1	1	1	1	1
Surface treatment of suspension and glass retainer profiles (16741, basic treatment fee to surface treatment, lump sumper colour)	<input type="checkbox"/> 14163 Powder-coated to RAL code .....						<input type="checkbox"/> 14630 Chrome effect, polished finish			
	<input type="checkbox"/> 14626 Plain, anodized, polished, brushed									

**Please note: orders can only be processed if this form has been filled out correctly.**

Date ..... Signature .....