







**Fitting for 2 top-running glass doors up to 16 kg (35 lbs.), with screwed on or groove mounted running track. With soft and self closing mechanism. Design Inside.**

**Product highlights**

-  **Comfort** Smooth, silent running with Comfort Roller and soft and self closing system for different door weights
-  **Productivity** No groove in the base and invisible technology

**Technical specifications**

-  Max. 16 kg (35 lbs.)
-  Max. 1400 mm (4'7 1/8")
-  Max. 1000 mm (3'3 3/8")
-  6-6.35 mm (1/4")

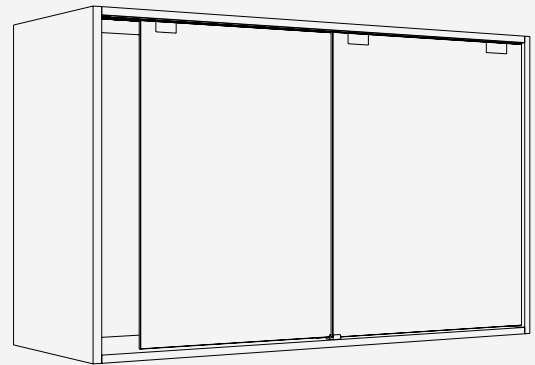

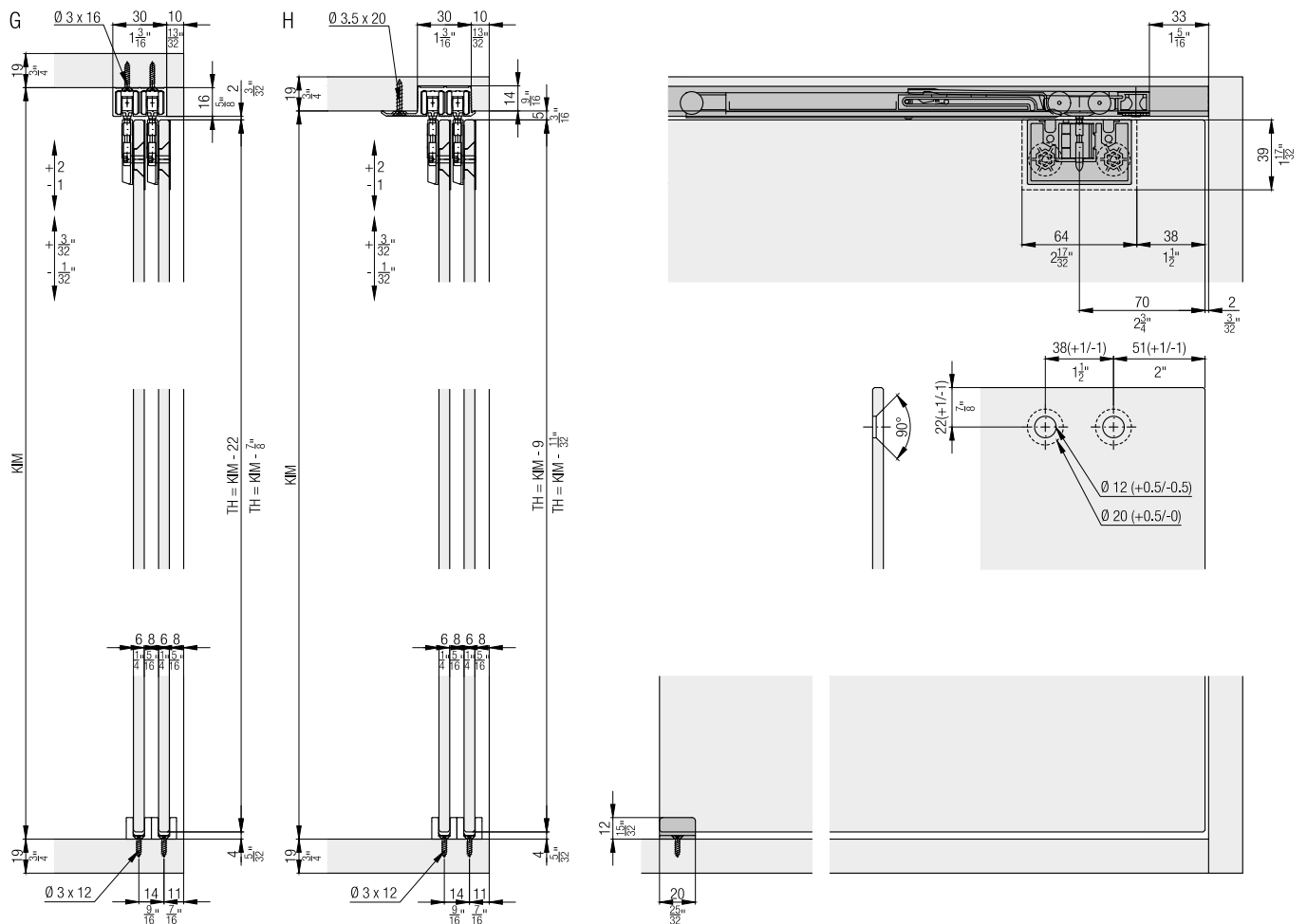

**Installation examples**



**Set for 2 glass doors up to 16 kg (35 lbs.),  
with height adjustment**

	No.
Hawa Clipo 16 GS IS, for 2 doors	053.3314.071

**Set consisting of:**

		053.3314.071	No.
	Running gear	4	053.0297.171
	Hawa Clipo 16/Hawa Regal 16 C stopper, plastic, gray	2	053.3215.071
	Fixing plate, for screw fixing, zinc diecast	4	053.3311.072
	Spacer, plastics	8	053.3312.071
	Button head socket screws, M4x8 (5/32"x5/16"), steel, zinc-plated	8	600.0000.677
	Panel	4	053.3319.171
	Door follower, plastic, grey	1	053.3075.071
	Socket button head screw, M3x6 mm (1/8"x 1/4"), steel, zinc-plated	1	600.0000.679
	Hex jam nut M3, steel, zinc-plated	1	600.0000.680
	Bottom guide, plastic, grey	2	053.3253.001
	Flat countersunk head chipboard screw, 3x12 mm (1/8"x15/32"), steel, zinc-plated	2	766.5030.112

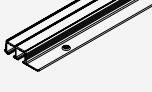

**Running tracks**

		mm (inch)	No.
	G: Double running track, for screw fixing, aluminum, anodized	2,500 (8' 2 7/16")	053.3247.250
		3,500 (11' 5 25/32")	053.3247.350
		6,000 (19' 8 7/32")	053.3247.600
	H: Double running track, aluminum, pre-drilled	2,500 (8' 2 7/16")	053.3248.250
		3,500 (11' 5 25/32")	053.3248.350
		6,000 (19' 8 7/32")	053.3248.600

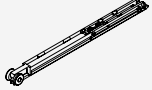
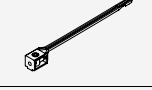

**Soft close up to 8/16 kg (17/35 lbs.)**

	No.
Soft close Hawa Clipo 16/Hawa Regal C 16, up to 8 kg (17 lbs.)	053.3332.071
Soft close Hawa Clipo 16/Hawa Regal C 16, up to 16 kg (35 lbs.)	053.3332.072

**Set consisting of:**

		053.3332.071	053.3332.072	No.
	Damper, up to 8 kg (17 lbs.)	2		053.3330.071
	Trigger, with stopper	2	2	053.3331.071
	Cross recessed pan head screw, 2.2x8 mm (3/32"x5/16"), steel, zinc-plated	2	2	600.0000.482
	Damper, up to 16 kg (35 lbs.)		2	053.3330.072

**Handles**

		No.
	Handle, for glue fixing, 64 mm (2 17/32"), plastic, chrome-plated, matt, 2-piece set	053.3323.971
	Finger-pull-handle, for glue fixing, 30 mm (1 3/16"), aluminum, anodized, 2-piece set	053.3091.982
	Finger-pull-handle, for glue fixing, 30 mm (1 3/16"), aluminum, anodized, 50-piece set	053.3091.983
	Finger-pull-handle, for glue fixing, 40 mm (1 9/16"), aluminum, anodized	053.3158.901

Accessories

		No.
	Track cleaner, plastic, red	040.3142.071

Calculations

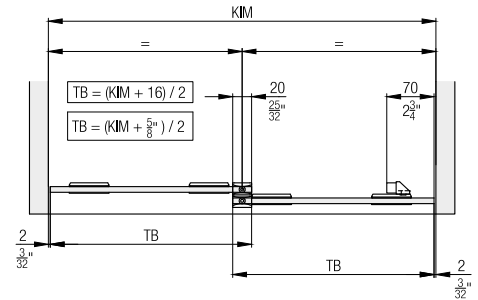

Door follower

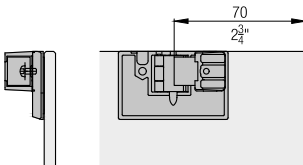

Soft close



	Z ≥	
	1	2
Hawa Clipo 16 H IS	1' 3 3/4"	1' 11 5/8"
Hawa Clipo 16 H MS	1' 5 1/4"	2' 1 1/8"
Hawa Clipo 16 H FS	1' 5 1/4"	2' 1 1/8"
Hawa Clipo 16 HM IS	1' 3 3/4"	1' 11 5/8"
Hawa Clipo 16 GK IS	1' 3 3/4"	1' 11 5/8"
Hawa Clipo 16 GS IS	1' 3 3/4"	1' 11 5/8"
Hawa Clipo 16 GPK IS	1' 3 3/4"	1' 11 5/8"
Hawa Clipo 16 GPPK IS	1' 3 3/4"	1' 11 5/8"

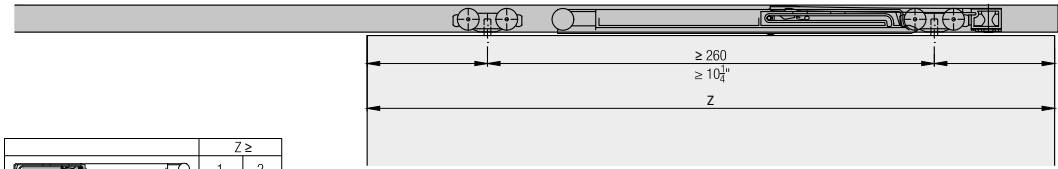

	Z ≥	
	1	2
Hawa Clipo 16 H IS	400	600
Hawa Clipo 16 H MS	438	638
Hawa Clipo 16 H FS	438	638
Hawa Clipo 16 HM IS	400	600
Hawa Clipo 16 GK IS	400	600
Hawa Clipo 16 GS IS	400	600
Hawa Clipo 16 GPK IS	400	600
Hawa Clipo 16 GPPK IS	400	600

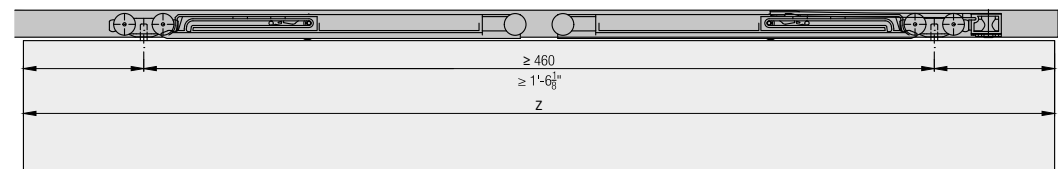

Accessories

– Glass recommendations from page 249

Planning/execution

Further information about the product can be found on [www.hawa.com](http://www.hawa.com).