

Fitting for 2–3 bottom-running wooden doors up to 35 kg (77 lbs.) with screwed on running track. Soft close optional. Design Forslide.

Product highlights



Comfort High operating convenience thanks to proven running system and optional soft closing technology



Productivity No cabinet processing, high degree of pre-assembly and access from the front for easy, quick installation

Technical specifications



Max. 35 kg (77 lbs.)



Max. 2200 mm (7'2 5/8")



Max. 1200 mm (3'11 1/4")



19 mm (3/4")

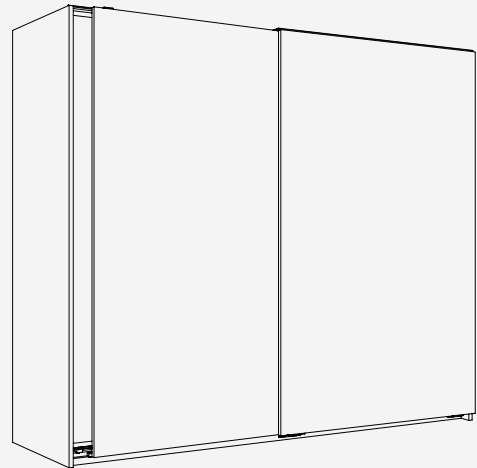

Installation examples

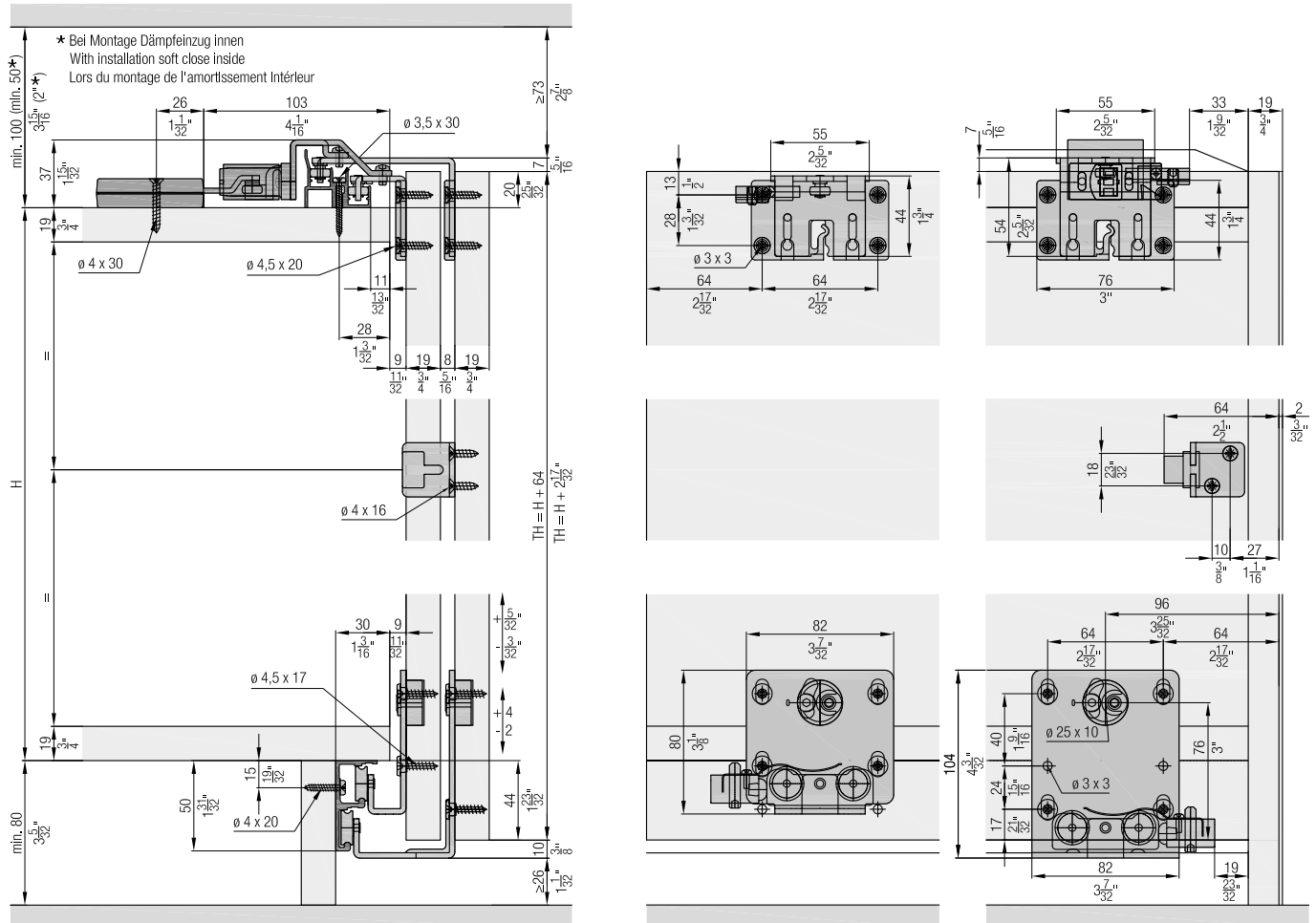

Set for 2 wooden doors

	Nr.
Hawa Combino 35 H FS, for 2 doors	056.3182.073
Hawa Combino 35 H FS, for 3 doors	056.3182.074

Set consisting of:

		056.3182.073	056.3182.074	Nr.
	Running gear, interior door, steel, zinc-plated	2	4	056.3187.171
	Running gear, exterior door, steel, zinc-plated	2	2	056.3188.171
	Guide bracket, interior door, steel, zinc-plated	2	4	055.3107.171
	Guide bracket, exterior door, steel, zinc-plated	2	2	055.3108.171
	Guide bracket housing, plastic, anthracite	4	6	053.3064.001
	Stopper, plastic, gray	2	1	056.3189.071
	Stopper, with retention spring, plastic, gray	2	3	056.3189.072
	Stopper guide, plastic, gray	4	4	040.3079.074
	Door follower, with 2 doors, steel, zinc-plated	1		055.3124.071
	Washer and screw assembly, 4.5x17 mm, steel, zinc-plated	16	24	055.0100.101
	Countersunk head screw, 4.5x20 mm, steel, zinc-plated	16	24	600.0000.167
	Buffer, with adhesive, 3-piece set		1	061.3083.050
	Door follower, with 3 doors, steel, zinc-plated		2	055.3126.171
	Thread-cutting rounded head screw, M4x8 mm, steel, zinc-plated		2	600.0000.328

Running tracks

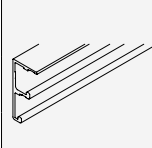
		mm (inch)	Nr.
	Double running track, aluminum, anodized, pre-drilled	2500 (8'2 7/16")	056.3184.250
		3500 (11'5 25/32")	056.3184.350
		6000 (19'8 7/32")	056.3184.600

Guide tracks

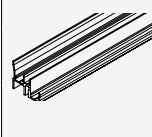

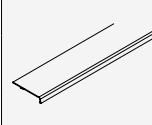

		mm (inch)	Nr.
	Double guide track, aluminum, anodized, pre-drilled	2500 (8'2 7/16")	056.3072.250
		3500 (11'5 25/32")	056.3072.350
		6000 (19'8 7/32")	056.3072.600

Panels

		mm (inch)	Nr.
	Cover panel, aluminum, anodized	2500 (8'2 7/16")	055.3130.250
		3500 (11'5 25/32")	055.3130.350
		6000 (19'8 7/32")	055.3130.600

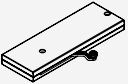
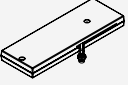



**Soft close (installation outside)
(only for system with 2 doors)
Adapter soft close (installation outside)
must be ordered separately**

	Nr.
Soft close, 18–40 kg (40–88 lbs.), with narrow follower, 2 pieces	055.3091.074

		055.3091.074	Nr.
Set consisting of:			
	Soft close, left, 18–40 kg (40–88 lbs.)	1	055.3090.073
	Soft close, right, 18–40 kg (40–88 lbs.)	1	055.3090.074
	Follower, for soft close, right, plastic, gray	1	055.3041.071
	Follower, for soft close, left, plastic, gray	1	055.3041.072
	Fillister head screw, 4x16 mm, steel, zinc-plated	4	600.0000.166
	Countersunk head screw, 4x30 mm, steel, zinc-plated	4	600.0000.439





**Adapter soft close (installation outside)
for No. 055.3091.074**

	Nr.
Adapter set, for soft close	055.3129.071

		055.3129.071	Nr.
Set consisting of:			
	Adapter, for soft close, interior door, top, steel, zinc-plated	1	055.0211.101
	Adapter, for soft close, exterior door, top, steel, zinc-plated	1	055.0212.101
	Rounded head screw, M4x8 mm, steel, zinc-plated	4	759.0408.108
	Thread-cutting rounded head screw, M4x8 mm, steel, zinc-plated	4	600.0000.328

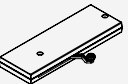
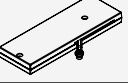
**Soft close (installation inside)
(only for system with 2 doors)**

	Nr.
Soft close, 18–40 kg (40–88 lbs.), with wide follower, 2 pieces	055.3091.073

		055.3091.073	Nr.
Set consisting of:			
	Soft close, left, 18–40 kg (40–88 lbs.)	1	055.3090.073
	Soft close, right, 18–40 kg (40–88 lbs.)	1	055.3090.074
	Follower, for soft close, right, plastic, gray	1	055.3040.071
	Follower, for soft close, left, plastic, gray	1	055.3040.072
	Fillister head screw, 4x16 mm, steel, zinc-plated	6	600.0000.166
	Countersunk head screw, 4x30 mm, steel, zinc-plated	4	600.0000.439

Accessories

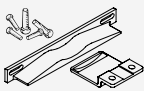
	Nr.
 Intermediate stop set, for 3 doors	055.3128.071

Soft close installation inside (only for system with 2 doors)

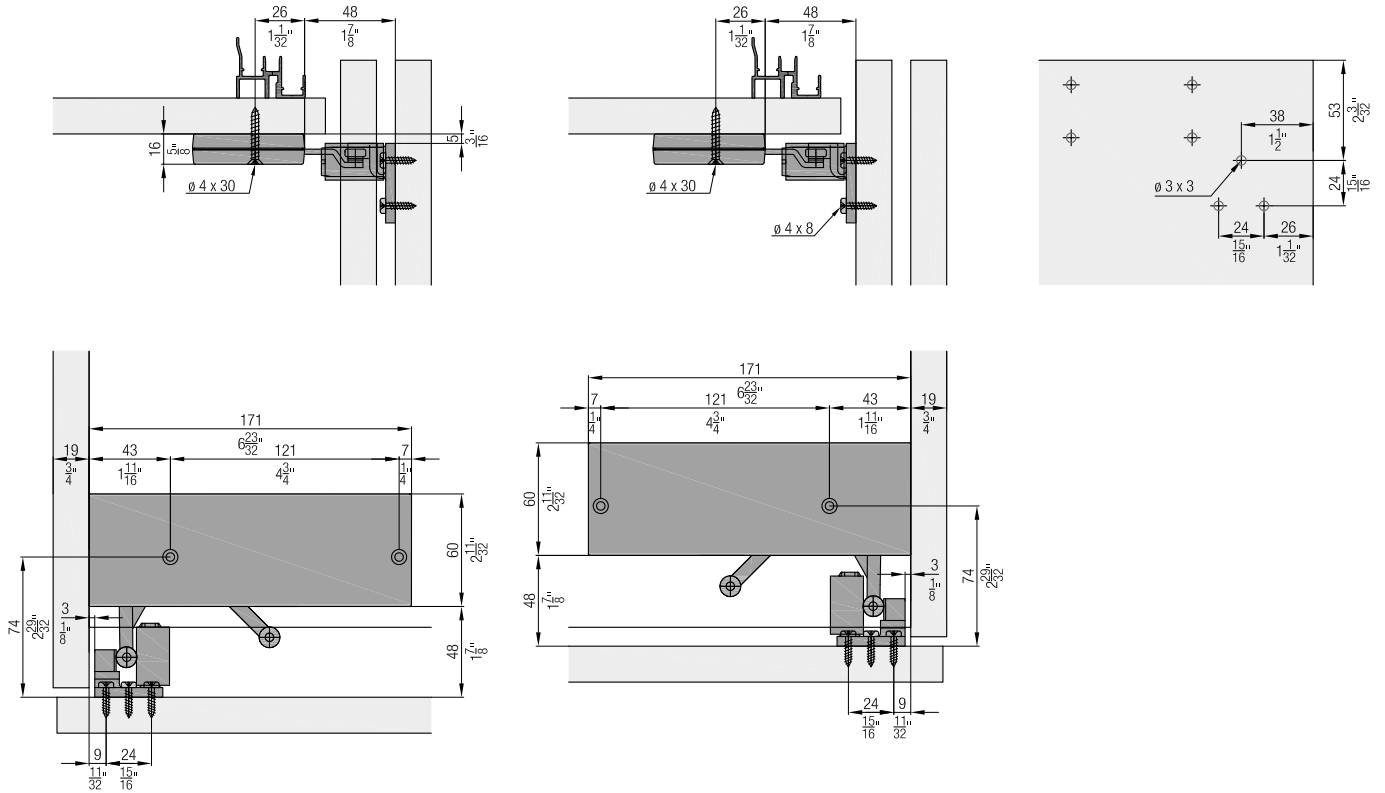

Soft close installation outside (only for system with 2 doors)

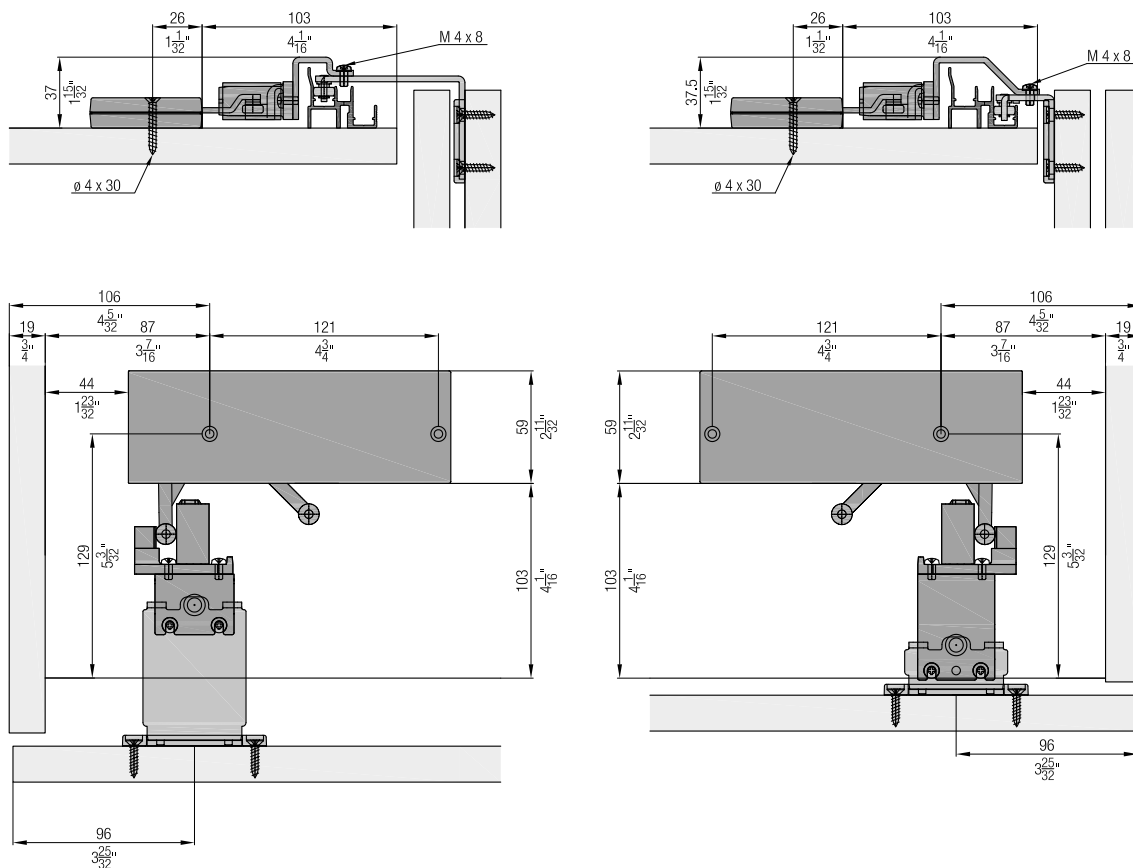

Calculations

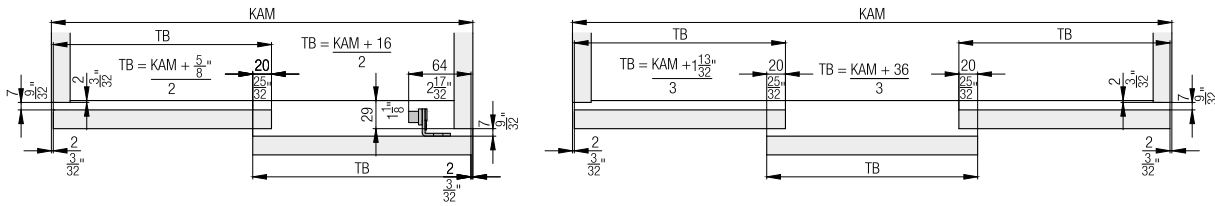

Optional: Guide track installation from below

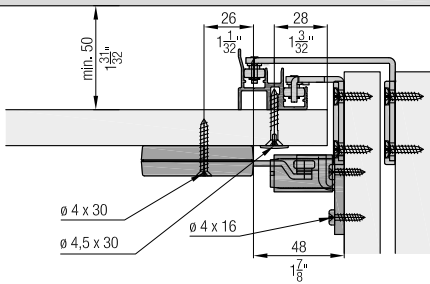

Intermediate stop with 3 doors

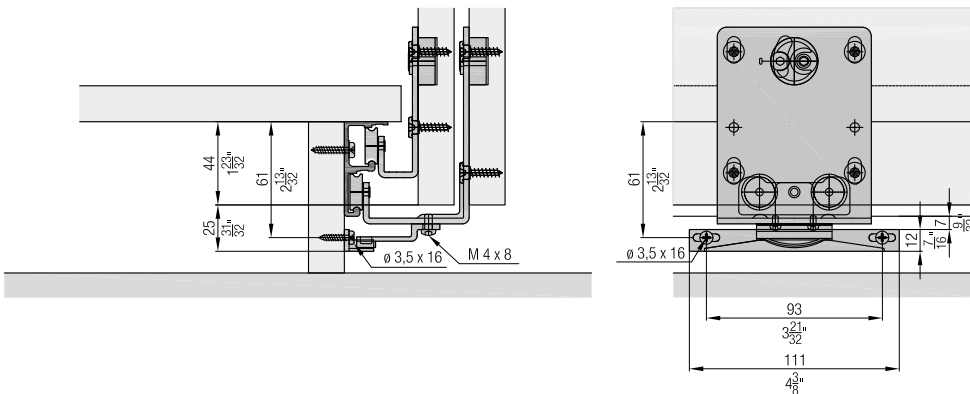

Handle profile

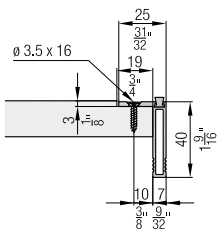

Accessories

- Straightening fitting from page 236
- Handle profiles from page 238
- Order overview soft close from page 240

Planning/execution

Further information about the product can be found on www.hawa.com.