







**Fitting for 2–3 bottom-running wooden doors (19/25 mm) up to 50 kg (110 lbs.) with screwed on running track and integrated soft close. Design Mixslide**

**Product highlights**

-  **Comfort** Sophisticated soft closing system and innovation arrangement of the components for very easy operation
-  **Aesthetics** Bottom-running system that supports the entire door weight on the base makes cabinet designs with thin materials possible

**Technical specifications**

-  Max. 50 kg (110 lbs.)
-  Max. 2400 mm (7'10 7/16")
-  Max. 1400 mm (4'7 1/8")
-  19/25 mm (3/4" or 31/32")

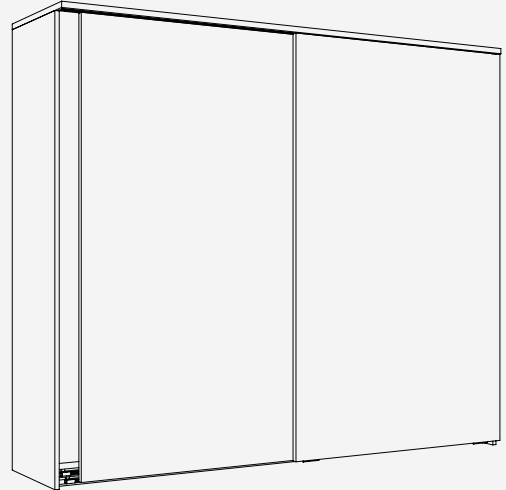



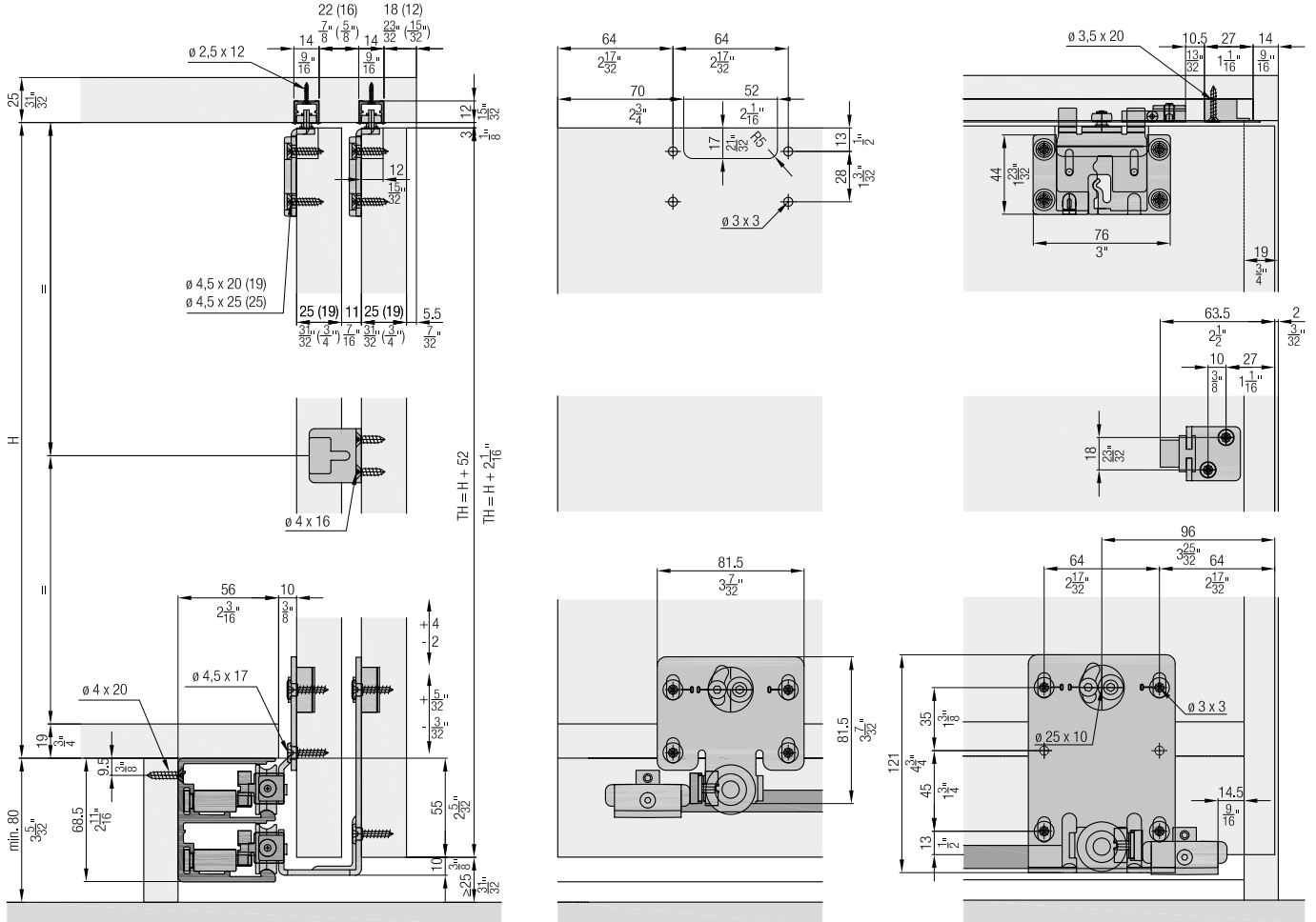













**Installation examples**



**Set for 2 or 3 wooden doors, 19 mm (3/4")**

	No.
Hawa Combino 50 H MS, door thickness 19 mm (3/4"), for 2 doors	055.3199.071
Hawa Combino 50 H MS, door thickness 19 mm (3/4"), for 3 doors	055.3199.073

















**Set consisting of:**

		055.3199.071	055.3199.073	No.
	Running gear, interior door, steel, zinc-plated	2	4	055.3169.071
	Running gear, exterior door, 19 mm (3/4"), steel, zinc-plated	2	2	055.3113.175
	Guide bracket, steel, zinc-plated	4	6	055.3059.171
	Guide bracket housing, plastic, anthracite	4	6	055.0282.001
	Anti-derailment device, plastic, red	4	6	055.0186.001
	Stopper, plastic, gray	4	4	055.3167.071
	Retention spring for stopper, plastic, gray	2	3	055.0204.001
	Stopper guide, plastic, gray	4	4	040.3079.074
	Door follower, with 2 doors, steel, zinc-plated	1		055.3124.071
	Track end piece, plastic, gray, 31 mm (1 7/32")	3	4	040.3083.002
	Track end piece, plastic, gray, 22 mm (7/8")	1		040.3083.003
	Washer-and-screw assembly, 4.5x17 mm, steel, zinc-plated	16	24	055.0100.101
	Countersunk head screw, 4.5x20 mm, steel, zinc-plated	16	24	600.0000.167
	Countersunk head screw, 3.5x20 mm, steel, zinc-plated	4	4	766.5035.120
	Door follower, with 3 doors, 2-piece set, steel, zinc-plated		1	056.3095.171
	Buffer, with adhesive, 2-piece set		1	053.3364.051

**Set for 2 or 3 wooden doors, 25 mm (31/32")**

	No.
Hawa Combino 50 H MS, door thickness 25 mm (31/32"), for 2 doors	055.3199.072
Hawa Combino 50 H MS, door thickness 25 mm (31/32"), for 3 doors	055.3199.074

**Set consisting of:**

		055.3199.072	055.3199.074	No.
	Running gear, interior door, steel, zinc-plated	2	4	055.3169.071
	Running gear, exterior door, 25 mm (31/32"), steel, zinc-plated	2	2	055.3114.175
	Guide bracket, steel, zinc-plated	4	6	055.3059.171
	Guide bracket housing, plastic, anthracite	4	6	055.0282.001
	Anti-derailment device, plastic, red	4	6	055.0186.001
	Stopper, plastic, gray	4	4	055.3167.071
	Retention spring for stopper, plastic, gray	2	3	055.0204.001
	Stopper guide, plastic, gray	4	4	040.3079.074
	Door follower, with 2 doors, steel, zinc-plated	1		055.3124.071
	Track end piece, plastic, gray, 31 mm (1 7/32")	3	4	040.3083.002
	Track end piece, plastic, gray, 22 mm (7/8")	1		040.3083.003
	Washer-and-screw assembly, 4.5x17 mm, steel, zinc-plated	16	24	055.0100.101
	Countersunk head screw, 4.5x25 mm, steel, zinc-plated	16	24	766.5045.125
	Countersunk head screw, 3.5x20 mm, steel, zinc-plated	4	4	766.5035.120
	Door follower, with 3 doors, 2-piece set, steel, zinc-plated		1	056.3095.171
	Buffer, with adhesive, 2-piece set		1	053.3364.051

**Running tracks**

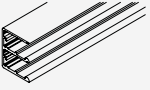
		mm (inch)	No.
	Double running track, aluminum, anodized, pre-drilled, for soft close	2500 (8'2 7/16")	055.3160.250
		3500 (11'5 25/32")	055.3160.350
		6000 (19'8 7/32")	055.3160.600

**Guide tracks**

		mm (inch)	No.
	Guide track, aluminum, pre-drilled	2500 (8'2 7/16")	056.3079.250
		3500 (11'5 25/32")	056.3079.350
		6000 (19'8 7/32")	056.3079.600

**Stopper extension**





For use without soft close order 4 pieces

		No.
	Stopper extension, plastic, gray	055.3168.071

**Soft close**

	No.
Hawa Combino 50 H MS/FS, up to 50 kg (110 lbs.), 2 pieces	055.3215.071
Hawa Combino 50 H MS/FS, up to 50 kg (110 lbs.), 4 pieces	055.3215.072

**Set consisting of:**

		055.3215.071	055.3215.072	No.
	Soft close, left, up to 50 kg (110 lbs.)	1	2	055.3166.072
	Soft close, right, up to 50 kg (110 lbs.)	1	2	055.3166.071
	Activator soft close	2	4	055.3165.071
	Stopper extension, plastic, gray	2		055.3168.071
	Thread-cutting head screw, M4x8 mm, steel, zinc-plated	2	4	600.0000.344

**Accessories**

	No.
	Drilling and milling jig, for processing guide brackets, wood 055.3099.001

**Track end piece**

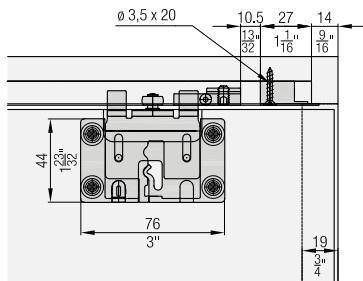
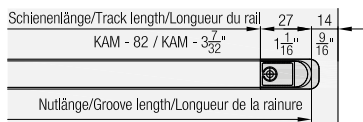

**Handle profiles**

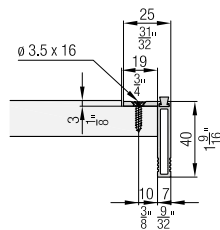

**Calculations**

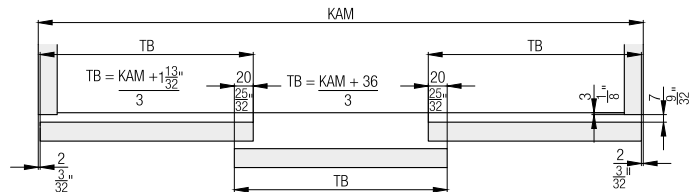
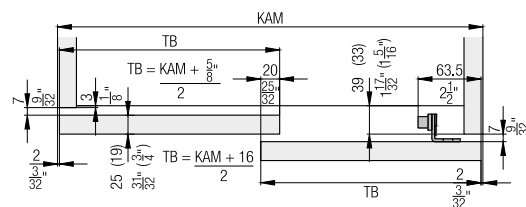

**Soft close**

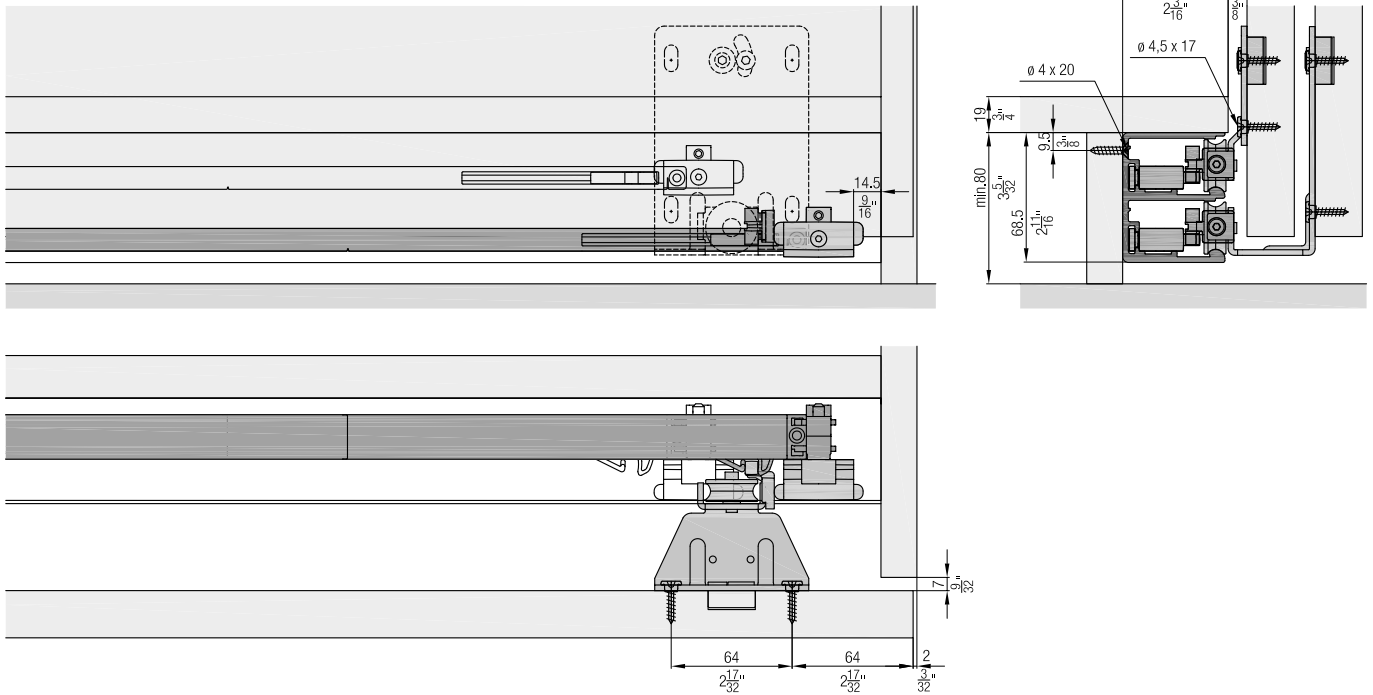

**Accessories**

- Straightening fitting from page 236
- Handle profiles from page 238
- Order overview soft close from page 240

**Planning/execution**

Further information about the product can be found on [www.hawa.com](http://www.hawa.com).