



Fitting for 2–10 folding sliding shutters made of wood or metal up to 30 kg (66 lbs.) per shutter and 180 kg (397 lbs.) per system, with concealed running and guide tracks. Design Forslide, open at the bottom.

Product highlights

-  **Aesthetics** Harmonious combination of shutters and façade, since the running and guide tracks disappear behind the closed shutter
-  **Flexibility** Solution for any construction situation with doors of up to 1.2 m² (13 ft²) and 30 kg (66 lbs.), even/odd number of doors and system width of up to 12 m (39' 4 7/16")

Technical specifications

-  Max. 30 kg (66 lbs.)
-  Max. 3200 mm (10'5 31/32")
-  Max. 600 mm (1'11 5/8")
-  28–36 mm (1 3/32"–1 13/32")

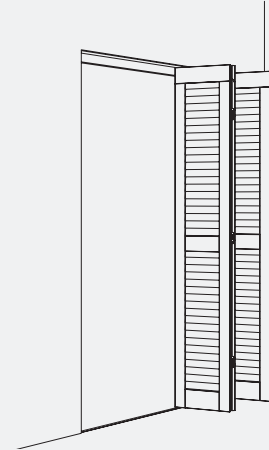

Installation examples

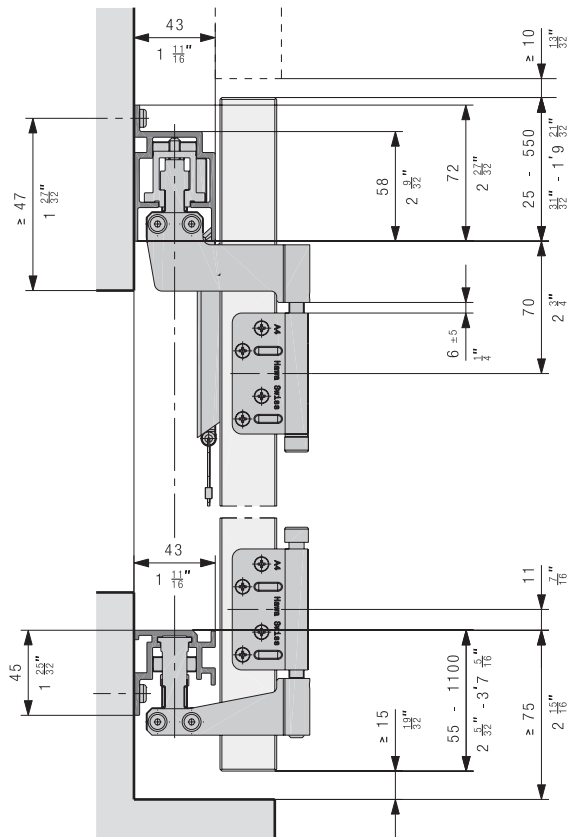

Set for folding packages

		No.
	Hawa Frontfold 30 FS, basic set right, guide track open at the bottom	27555
	Hawa Frontfold 30 FS, basic set left, guide track open at the bottom	27556
	Hawa Frontfold 30 FS, additional set, guide track open at the Bottom	27557

Set consisting of:	27555	27556	27557	No.
	1			27517
	1			27519
	1			27528
	1			27529
	4	4	2	27401
	2	2	1	15740
	4	4		27418
		1		27518
		1		27520
		1		27527
		1		27530
			1	27521
			1	27531
			4	27419

Set for uneven number of leaves

	No.
Hawa Frontfold 30 FS uo, set for uneven number of leaves left	30164
Hawa Frontfold 30 FS uo, set for uneven number of leaves right	30167



Set consisting of:

Set consisting of:	30164	30167	No.
	1		27518
	1		27527
	2	2	27418
	2	2	27401
	1	1	15740
		1	27517
		1	27528

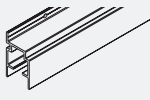
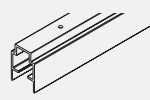
Running tracks

		mm (inch)	No.
	Running track, Forslide, wall mounting, aluminum, anodized	6000 (19'8 7/32")	27358
		cut to size	27622
	Running track, Forslide, ceiling mounting, aluminum, anodized	6000 (19'8 7/32")	27360
		cut to size	27623

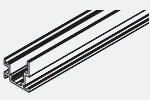





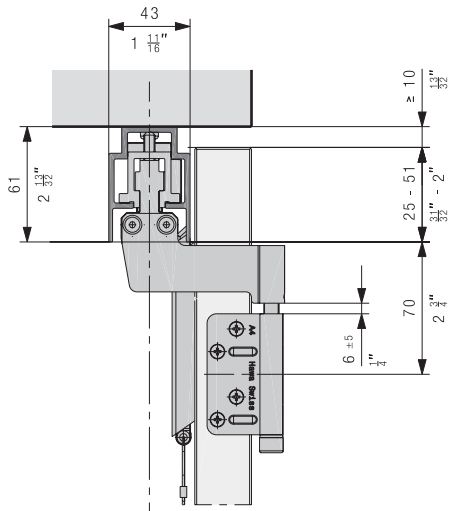



Guide tracks

		mm (inch)	No.
	Guide track, wall mounting, aluminum, anodized	6000 (19'8 7/32")	27364
		cut to size	27625
	Guide track, floor mounting, aluminum, anodized	6000 (19'8 7/32")	27366
		cut to size	27626
	Guide track, narrow, aluminum, anodized	6000 (19'8 7/32")	27368
		cut to size	27627

Running track, mounted on ceiling



Accessories

		No.
	Tension latch, opening outwards, with steel cable, without fixing screws	27490
	Tension latch, opening inwards, with steel cable, without fixing screws	27491
	Rotary handle for tension latch, stainless steel	27458
	Flat hinge, gap size 1-6 mm, (1/32" to 1/4") stainless steel A4	27421
	Cranked hinge, gap size 6 mm, stainless steel A4	27595
	Hinge plate cranked, two pieces, stainless steel A4	27419
	Hinge plate flat, two pieces, stainless steel A4	27420
	Hinge pin A4	20187
	Drilling jig for hinge, Ø 3mm for screw fixing, including threaded bolt	27551
	Drilling jig for hinge, Ø 5mm for riveting, including threaded bolt	27552
	Stop with adjusting screw, suitable for profile bar 8 mm from the espagnolette locking device	15899

Planning folding package

Customer installation of a wind support is recommended.

With an odd number of doors, the last door must be secured by the customer.

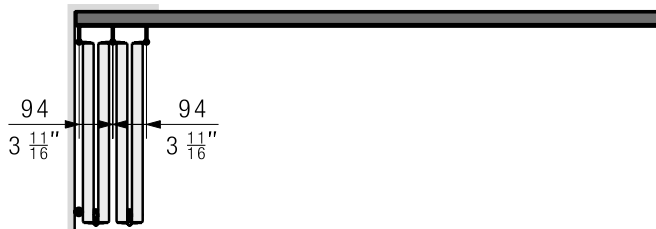

Running gear and guide hinge

With folding sliding shutters more than 33 mm (1 5/16") thick, the hinges must be embedded.

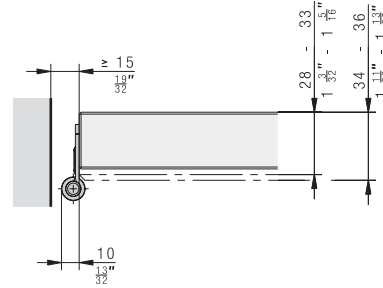

Options folding hinges

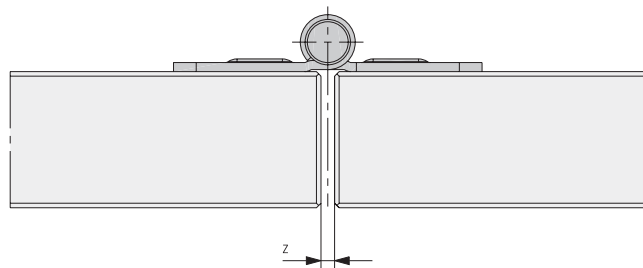

Variant 1, flat hinge: Z = 1-6 mm (1/32" to 1/4")

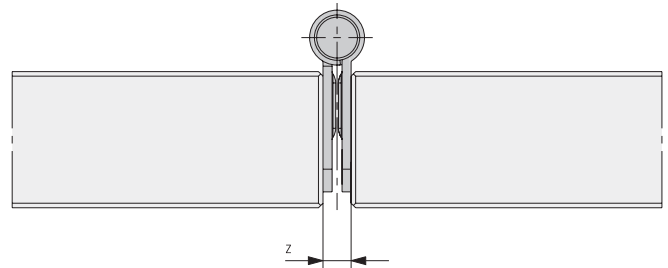

Variant 2, cranked hinge: Z = 6 mm (1/4")

Gap sizes

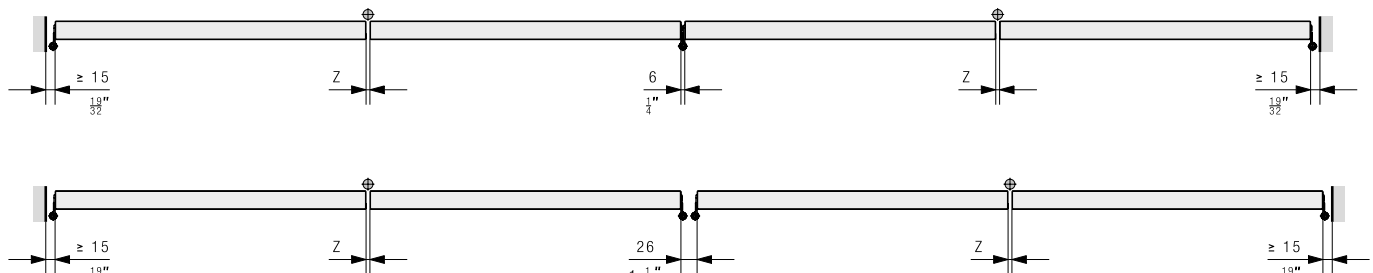

Number of hinges

Height	Quantity
up to 2000 mm	2
from 2001 mm	3

Ordering information

- Type and number of sets
- Type and number of hinges
- Type and number of tension latches and rotary handles
- Type and number of running tracks
- Type and number of guide tracks

Optional ordering information

- Type and number of drilling jigs
- Order overview from page 194

Planning/execution

Further information about the product can be found on www.hawa.com.