





Fitting for 2–10 folding sliding shutters made of wood or metal up to 30 kg (66 lbs.) per shutter and 180 kg (397 lbs.) per system. Inside running for tight spaces. Design Inside.

Product highlights

- 
**Flexibility** Solution for any construction situation with doors of up to 1.2 m<sup>2</sup> (13 ft<sup>2</sup>) and 30 kg (66 lbs.), even/odd number of doors and system width of up to 12 m (39' 4 7/16")
- 
**Flexibility** Tension latches available for inwards-folding systems

Technical specifications

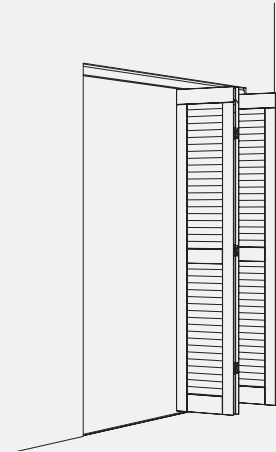

-  Max. 30 kg (66 lbs.)
-  Max. 3200 mm (10'5 31/32")
-  Max. 600 mm (1'11 5/8")
-  28–36 mm (1 3/32"–1 13/32")



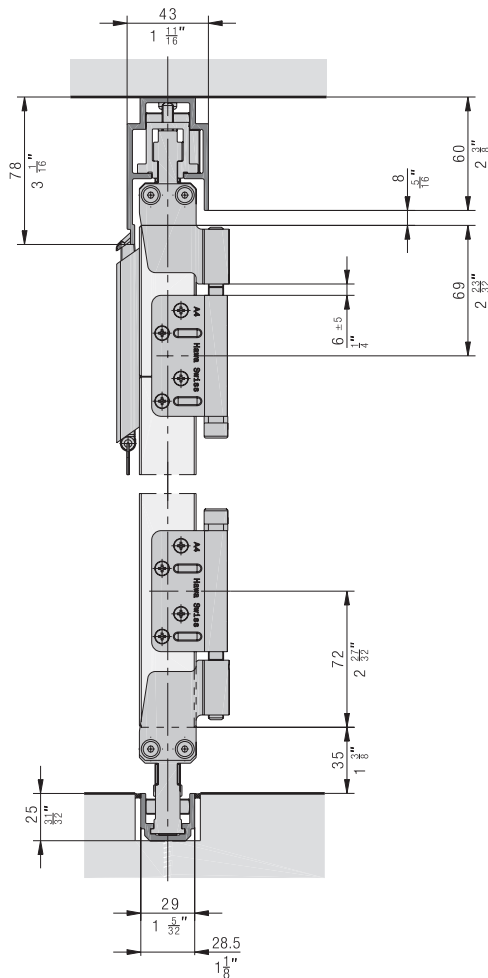













Installation examples



Set for folding packages

		No.
	Hawa Frontfold 30 IS, basic set right	27567
	Hawa Frontfold 30 IS, basic set left	27568
	Hawa Frontfold 30 IS, additional set	27569







Set consisting of:

		27567	27568	27569	No.
	Fixed suspension, Inslide, folding to the right	1			27523
	Running gear outside, Inslide, folding to the right	1			27524
	Fixed guide, Inslide, folding to the right	1			27539
	Outside guide, Inslide, folding to the right	1			27540
	Cylinder screw, M8x100 mm, A4-70	4	4	2	27401
	Hinge ring, plastic	2	2	1	15740
	Hinge plate cranked, one-piece, stainless steel A4	4	4		27418
	Fixed suspension, Inslide, folding to the left		1		27522
	Running gear outside, Inslide, folding to the left		1		27525
	Fixed guide, Inslide, folding to the left		1		27538
	Outside guide, Inslide, folding to the left		1		27541
	Centre running gear, Inslide			1	27526
	Centre guide, Inslide			1	27542
	Hinge plate cranked, two pieces, stainless steel A4			4	27419

Set for uneven number of leaves

	No.
Hawa Frontfold 30 IS, set for uneven number of leaves left	30175
Hawa Frontfold 30 IS, set for uneven number of leaves right	30176

Set consisting of:

		30175	30176	No.
	Fixed suspension, Inslide, folding to the left	1		27522
	Fixed guide, Inslide, folding to the left	1		27538
	Hinge plate cranked, one-piece, stainless steel A4	2	2	27418
	Cylinder screw, M8x100 mm, A4-70	2	2	27401
	Hinge ring, plastic	1	1	15740
	Fixed suspension, Inslide, folding to the right		1	27523
	Fixed guide, Inslide, folding to the right		1	27539



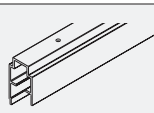









Running tracks

		mm (inch)	No.
	Running track, Inslide, aluminum, anodized	6000 (19'8 7/32")	27362
		cut to size	27624

Guide tracks

		mm (inch)	No.
	Guide track, narrow, aluminum, anodized	6000 (19'8 7/32")	27368
		cut to size	27627

**Accessories**

		No.
	Tension latch, opening outwards, with steel cable, without fixing screws	27490
	Tension latch, opening inwards, with steel cable, without fixing screws	27491
	Rotary handle for tension latch, stainless steel	27458
	Flat hinge, gap size 1–6 mm (1/32" to 1/4"), stainless steel A4	27421
	Cranked hinge, gap size 6 mm (1/4"), stainless steel A4	27595
	Hinge plate cranked, two pieces, stainless steel A4	27419
	Hinge plate flat, two pieces, stainless steel A4	27420
	Hinge pin A4	20187
	Drilling jig for hinge, Ø 3mm (1/8") for screw fixing, including threaded bolt	27551
	Drilling jig for hinge, Ø 5mm (3/16") for riveting, including threaded bolt	27552
	Stopper with adjusting screw, suitable for profile bar 8 mm (5/16") from the espagnolette locking device	15899
	Strike plate, stainless steel, A4 to pull lach folding inwards	30464

**Running track folding inwards**

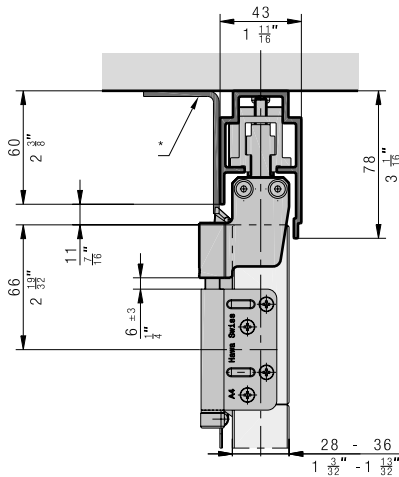

\* to be provided by customer

**Planning folding package**

Customer installation of a wind support is recommended.

With an odd number of doors, the last door must be secured by the customer.

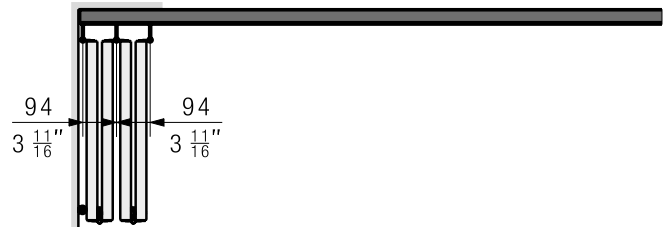

**Running gear and guide hinge**

With folding sliding shutters more than 33 mm (1 5/16 inches) thick, the hinges must be embedded.

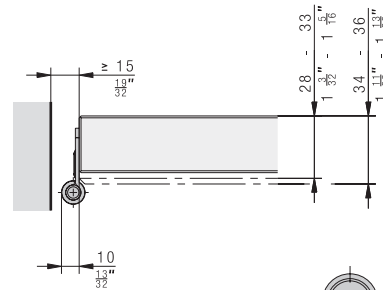

**Options folding hinges**

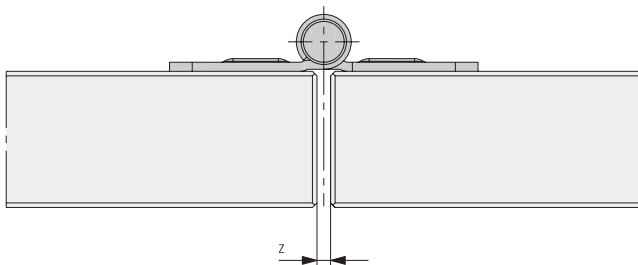

Variant 1, flat hinge: Z = 1–6 mm (1/32" to 1/4")

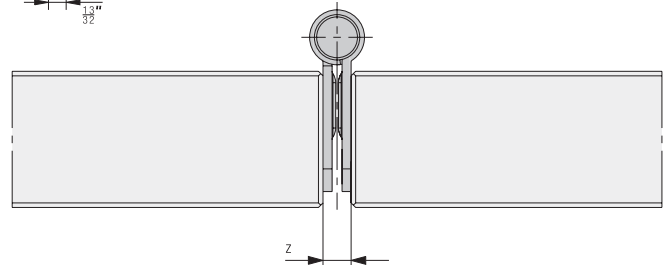

Variant 2, cranked hinge: Z = 6 mm (1/4")

**Gap sizes**

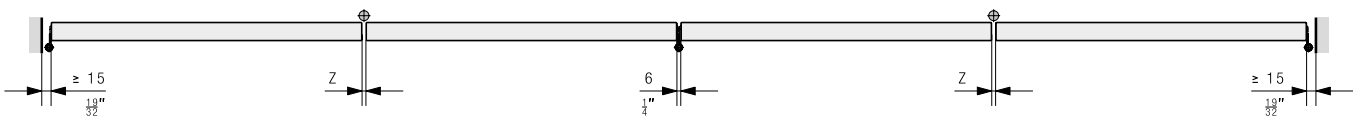

**Number of hinges**

Height	Quantity
up to 2000 mm	2
from 2001 mm	3

**Ordering information**

- Type and number of sets
- Type and number of hinges
- Type and number of tension latches and rotary handles
- Type and number of running tracks
- Type and number of guide tracks

**Optional ordering information**

- Type and number of drilling jigs
- Order overview from page 194

**Planning/execution**

Further information about the product can be found on [www.hawa.com](http://www.hawa.com).