



Fitting for top-running wooden doors up to 80 kg (176 lbs.), with surface mounted running track. Optionally with soft and self closing mechanism. Ceiling mounting. Wall pocket solution.

Product highlights

-  **Flexibility** The running track can be installed and removed at any time
-  **Aesthetics** Thanks to integrated spring stop with Push-to-open function, there are no visible hardware components, door milling grooves or spring handles at the edge of the door

Technical specifications

-  Max. 80 kg (176 lbs.)
-  Max. 4000 mm (13'1 15/32")
-  Max. 1500 mm (4'11 1/16")
-  35–80 mm (1 3/8" to 3 5/32")

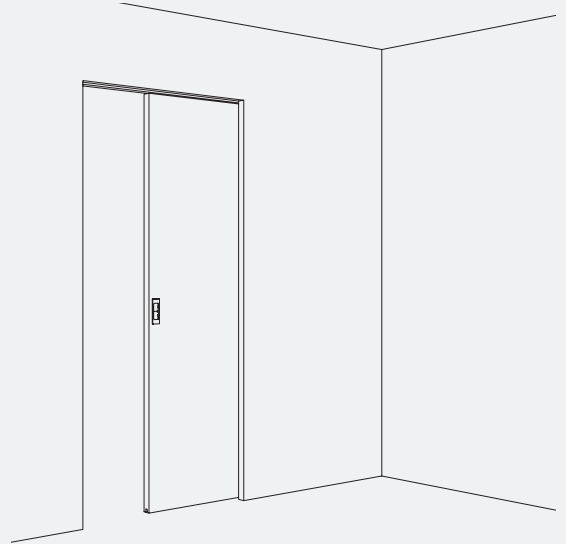



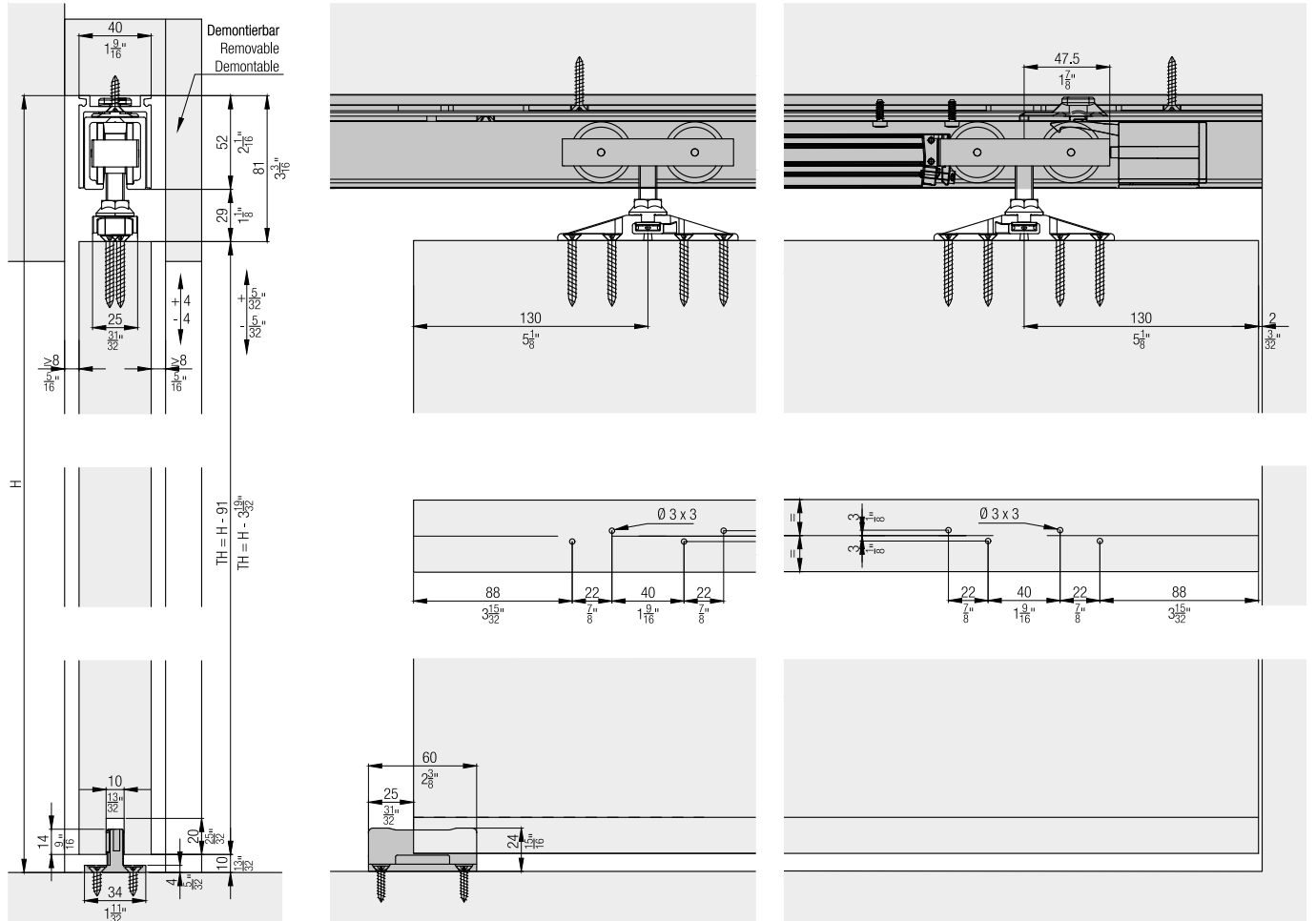

Installation examples



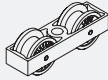
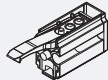

Set for 1 wooden door up to 80 kg (176 lbs.)

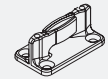
	No.
Hawa Junior 80 Z, with 1 track stopper, for 1 door	11705

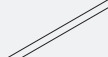
Set consisting of:

	11705	No.
 Running gear, 2-wheeled, M10, plastic wheels	2	10407
 Stopper Hawa Junior 80/100, with adjustable retention spring	1	30138
 Two-way suspension flange, with screw M10 and fixing screws, steel, zinc-plated	2	10489
 Bottom guide, zero tolerance, groove width 10 mm (13/32"), plastic black	1	14427
 Screw-on rubber door stop	1	10629
 Vertical adjustment pin	1	10795

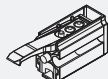
Accessories for set

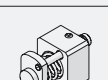
	No.
 Stopper Hawa Junior 80/100, with adjustable retention spring	30138
 SoftStop Hawa Junior 80/100, with adjustable retention spring	27771
 Spring loaded stopper Hawa Junior 80/100	25370

Running tracks

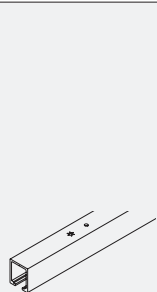

	mm (inch)	No.
 Running track, aluminum, anodized, pre-drilled	1,400 (4' 7 1/8")	10189
	1,600 (5' 3")	10190
	1,800 (5' 10 7/8")	10191
	2,000 (6' 6 3/4")	10192
	2,200 (7' 2 5/8")	10193
	2,500 (8' 2 7/16")	10194
	3,000 (9' 10 1/8")	18532
	cut to size	10188

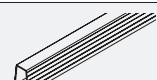
Guide tracks

	mm (inch)	No.
 Guide track, for groove mounting, plastic, 10-piece set	1,300 (4' 3 3/16")	14540

Assembly set, up to 2000 mm (6'6 3/4")

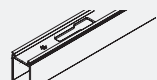

	No.
Set for mountable and demountable running track	25207

	mm (inch)	25207	No.
 Retainer profile with a bayonet lock, aluminum, anodized	2,035 (6'8 1/8")	1	25212
 Small parts to retainer profile, 6-piece set		1	25520

Assembly set, up to 2500 mm (8'2 7/16")

		No.
Set for mountable and demountable running track		25371

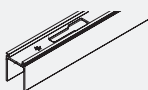

Set consisting of:

		mm (inch)	25371	No.
	Retainer profile with a bayonet lock, aluminum, anodized	2,535 (8'3 13/16")	1	25443
	Small parts to retainer profile, 7-piece set		1	25521

Assembly set, up to 3000 mm (9'10 1/8")

		No.
Set for mountable and demountable running track		25441

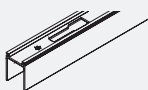
Set consisting of:

		mm (inch)	25441	No.
	Retainer profile with a bayonet lock, aluminum, anodized	3,035 (9'11 1/2")	1	25444
	Small parts to retainer profile, 9-piece set		1	25522

Panels

		mm (inch)	No.
	Clip-on panel, for fascia mounting, aluminum, anodized	2,000 (6'6 3/4")	25445
		cut to size	27693

Soft close SoftMove 80

For soft closing in opening and closing direction
order 2 sets.

		No.
	Soft closing mechanism SoftMove 80	22444

Accessories

		No.
	Bottom guide, rattle proof, groove width 10 mm (13/32"), plastic, black, 10-piece set	25958

SoftMove 80 soft closing mechanism

Completely integrated into the running track, the SoftMove decelerates sliding doors and draws them into their final position.

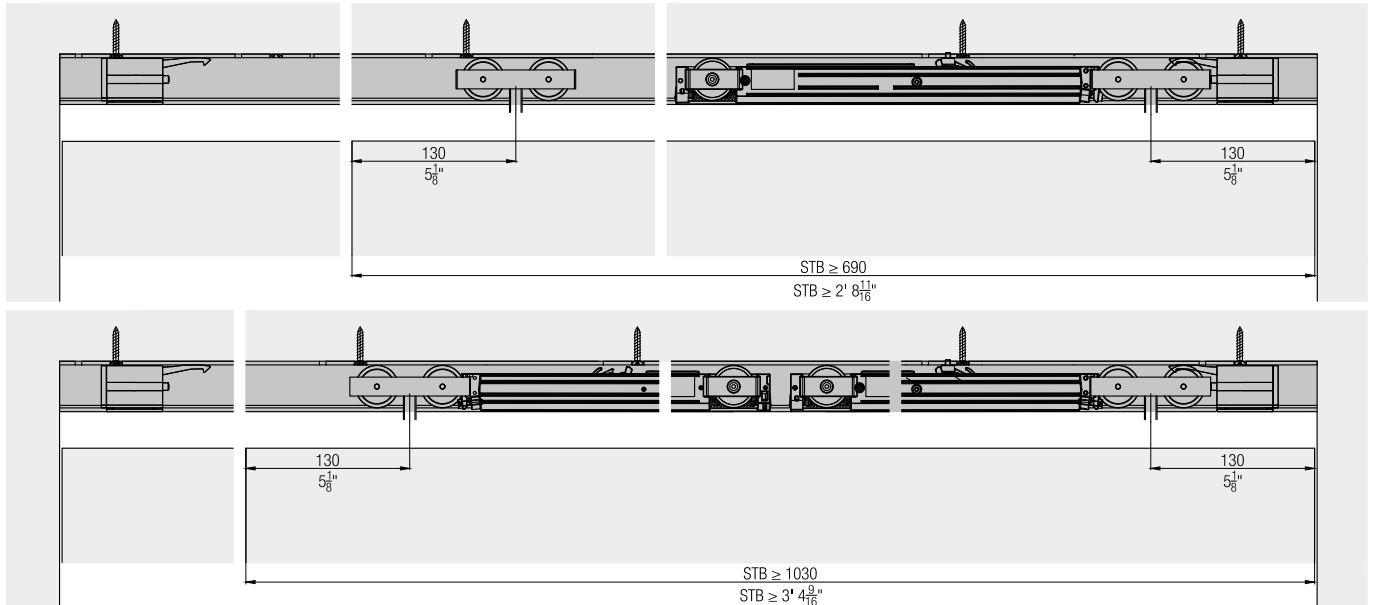

Accessories

- Hawa Junior bottom guides for wall mounting from page 508
- Lock solutions from page 511
- General accessories from page 518

Planning/execution

Further information about the product can be found on www.hawa.com.