



## Accessories

### Lock for all-glass sliding door Hawa Toplock for securing single- and double-panel systems. Fully tempered monolithic glass (ESG) and fully tempered laminated glass (VSG).

#### Product highlights

 **Flexibility** Securing sliding doors fitted with a 17 mm (21/32") profile, 22 mm (7/8") round cylinder or thumbturn four-square lock 8 mm (5/16")

 **Productivity** Simple installations

#### Technical specifications

Possible glasses:

→|< ESG: 8/10/12/12,7 mm (5/16", 13/32", 15/32", 1/2"), thickness tolerance  $\pm 0,3$  mm

→|< VSG from ESG: 2x4  $\pm 0,2$  mm: thickness tolerance 0,38/0,76/1,52 mm  
 VSG from ESG: 2x5  $\pm 0,2$  mm: thickness tolerance 0,38/0,76/1,52 mm  
 VSG from ESG: 2x6  $\pm 0,2$  mm: thickness tolerance 0,38/0,76 mm

All glass edges are seamed; maximum 1 mm (1/32") in the glass cutout

VSG (fully tempered laminated glass) permissible with max. offset of 2 mm (3/32") in the glass cutout

#### Installation examples

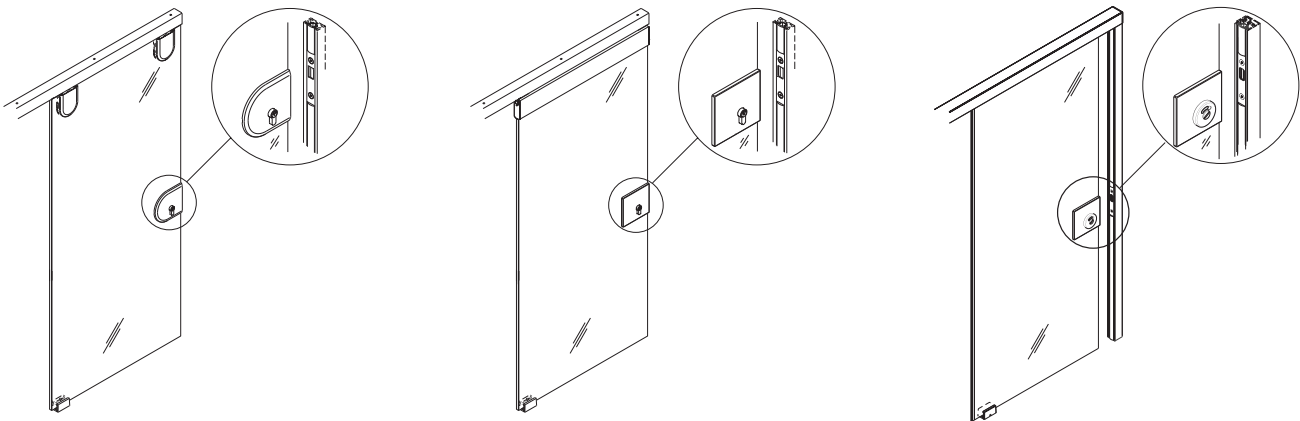

#### Lock front view

The outside dimensions of the rounded and square cover plates are identical.

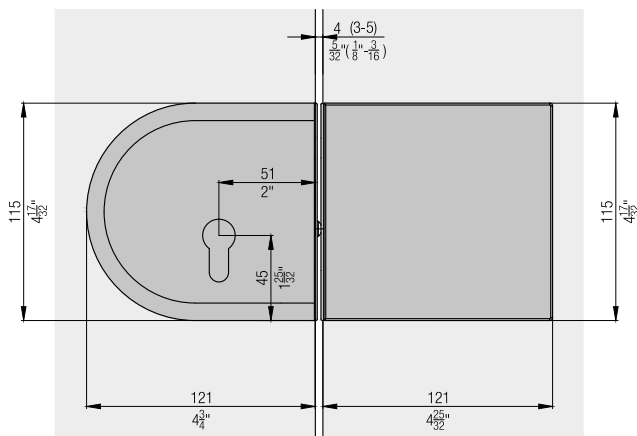

#### Glass cutout A

For lock for sliding door and counter casing.

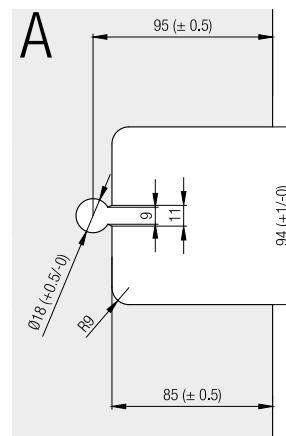

#### Glass cutout B

For lock bracket.

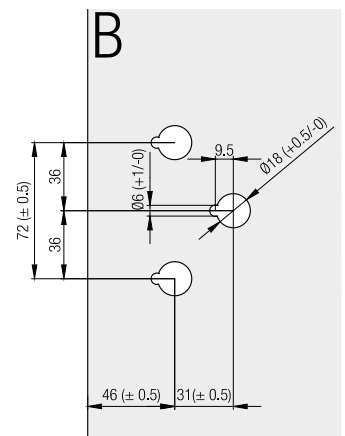

Installation options

with counter casing		with fixed glass		with angle profile for wall mounting		with wall connection profile		with wall profile for wall mounting	
glass cutout <b>A</b>	glass cutout <b>A</b>	glass cutout <b>A</b>	glass cutout <b>B</b>	glass cutout <b>A</b>	lock bracket	glass cutout <b>A</b>	wall profile	glass cutout <b>A</b>	wall profile wall mounting
Hawa Junior 40/80/120/160 GP Hawa Junior 80/120/160/250 G Hawa Telescopic 80 G Hawa Symmetric 80 G Hawa Junior 40-80 GS Hawa Puro 100/150 Hawa Purolo Plus 80		Hawa Junior 40/80/120 GP Hawa Junior 80/120 G Hawa Puro 100/150 Hawa Purolo Plus 80		Hawa Junior 40/80/120 GP Hawa Junior 80/120 G Hawa Purolo Plus 80		Hawa Junior 40/80/120/160 GP Hawa Junior 80/120/160 G Hawa Telescopic 80 G Hawa Junior 40/80 GS Hawa Puro 100/150 Hawa Purolo Plus 80		Hawa Junior 40/80 GP Hawa Purolo Plus 80	

Hawa Toplock

	mm (inch)	No.
	Hawa Toplock, lock for all-glass sliding door, 17 mm (21/32"), without cover plates	20494
	Hawa Toplock, lock for all-glass sliding door, 22 mm (7/8"), without cover plates	20495
	Hawa Toplock, lock for all-glass sliding door, 8 mm (5/16") square, without cover plates	22097
	Counter casing, including centering assemblies	20496
	Multi-purpose drilling jig for lock and counter casing	17162
	Security rose 12 mm (15/32"), for profile cylinder 17/61 mm, chrome nickel steel	14147
		14 (9/16")

Profile cylinder

	No.	
	Short cylinder 28 mm (1 3/32"), with 2 triangular keys, dull nickel finish	24287
	Short cylinder 28 mm (1 3/32"), with 2 triangular keys, dull chromium finish	24288

Provided by customer

	Standard thumbturn with rosette for four-square lock 8 mm (5/16")
--	---

Wall connection profile

	mm (inch)	No.	
	Wall profile, aluminium, anodized	2500 (8' 2 7/16")	17020
		3500 (11' 5 25/32")	17021
	Wall profile, aluminum, stainless steel look, brushed	2500 (8' 2 7/16")	20119
		3500 (11' 5 25/32")	20120
	Wall profile for wall mounting, aluminium, anodized, pre-drilled	2500 (8' 2 7/16")	22144
		3500 (11' 5 25/32")	22146
	Wall profile for wall mounting, aluminium stainless-steel effect, pre-drilled	2500 (8' 2 7/16")	22145
		3500 (11' 5 25/32")	22147
	Seal profile, black, for wall profile	2500 (8' 2 7/16")	16452
		3500 (11' 5 25/32")	16453
	Strike plate for wall profile, including centering assemblies		17182

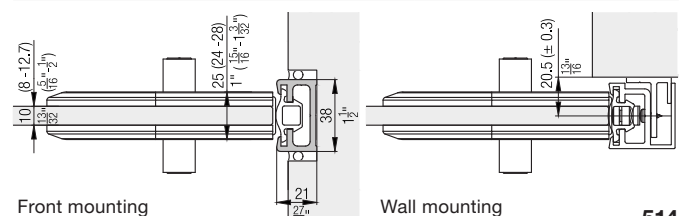

# Accessories

## Components for fixed glass or side fitting

	a	b	c	a	b
Hawa Junior 40	 17203	 1 mm (1/32")	 20497	 17203	 3 mm (1/8")
Hawa Junior 80	 17203	 3 mm (1/8")	 20497	 17203	 6 mm (1/4")
Hawa Puro 100/150	 17203	 3 mm (1/8") 1 mm (1/32")	 20497		
Hawa Junior 120	 17203	 9 mm (11/32")	 20497	 17203	 12 mm (15/32")
Hawa Purolino Plus 80	 17203	 12 mm (15/32")		 17203	 6 mm (1/4")





### Lock bracket





	No.
 Lock bracket, without cover plate	17203
 Lock attachment bracket for stationary glass, without cover plates	20497

### Spacer for lock bracket

		thickness (inch)	No.
	Spacer 9 mm for lock bracket in combination, with fixed glass, aluminium, anodized	9 mm (11/32")	20276
	Spacer 9 mm for lock bracket in combination, with wall mounting, aluminium, anodized	3 mm (1/8")	19621
		6 mm (1/4")	17688
		12 mm (15/32")	19622

Cover plates

		No.
	Rounded cover plates, for 17 mm (21/32") cylinder, plastic, dull chromium finish, 1 pair	17184
	Rounded cover plates, for 17 mm (21/32") cylinder, plastic, stainless-steel effect, 1 pair	17186
	Rounded cover plates, for 22 mm (7/8") cylinder, plastic, dull chromium finish, 1 pair	17189
	Rounded cover plates, for 22 mm (7/8") cylinder, plastic, stainless-steel effect, 1 pair	17191
	Rounded cover plate, for counter casing, plastic, dull chromium finish, 1 piece	17194
	Rounded cover plate, for counter casing, plastic, stainless-steel effect, 1 piece	17196
	Rounded cover plate, for lock bracket, plastic, dull chromium finish, 1 piece	17204
	Rounded cover plate, for lock bracket, plastic, stainless-steel effect, 1 piece	17206
	Rounded cover plate, for lock attachment bracket for stationary glass, dull chromium finish	18525
	Rounded cover plate, for lock attachment bracket for stationary glass, stainless-steel effect	18527

		No.
	Cover cap, square, for 17 mm (21/32") cylinder, plastic, matt chromium finish, 1 pair	19095
	Cover cap, square, for 17 mm (21/32") cylinder, plastic, stainless-steel effect, 1 pair	19096
	Cover cap, square, for 22 mm (7/8") cylinder, plastic, matt chromium finish, 1 pair	19098
	Cover cap, square, for 22 mm (7/8") cylinder, plastic, stainless-steel effect, 1 pair	19099
	Square cover plates, for square lock, plastic, dull chromium finish, 1 pair	22100
	Square cover plates, for square lock, plastic, stainless-steel effect, 1 pair	22101
	Cover cap, square, for counter casing, plastic, matt chromium finish, 1 piece	19101
	Cover cap, square, for counter casing, plastic, stainless-steel effect, 1 piece	19102

**Order specifications**

- Quantity lock for all-glass sliding door
- Type of cylinder, 17, 22 mm (21/32", 7/8") or four-square lock 8 mm (5/16")
- Type and quantity of cover plates
- Drilling jig
- Counter part requirement for lock for all-glass sliding door:
  - Quantity counter casing, including centering assemblies
  - Quantity lock bracket
  - Quantity and type wall connection profile
- Provided by customer: DreThumbturn with rosette for four-square lock 8 mm (5/16")

**Order specifications optional**

- Quantity lock bracket fixture for fixed glass
- Quantity and type spacer for lock bracket
- Quantity and type Security rose for profile cylinder

**Planning/installation**

For planning and installation purposes, please use the installation drawing code 17199. Further information about the product can be found on [www.hawa.com](http://www.hawa.com).