

## Ferrure pour 2 portes en bois à roulement en haut jusqu'à 16 kg avec rail de roulement vissé en applique ou rail de roulement rainuré. Avec amortisseur. Design Inside.

### Produits phares



#### Confort

Coulissement léger et silencieux avec Galet de Confort et un amortissement pour retour automatique par traction pour différents poids de porte



#### Productivité

Efficace grâce au montage de porte sans outil et à un réglage simple et intuitif

### Spécifications techniques

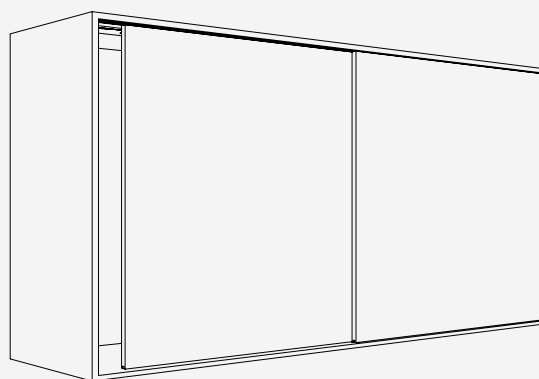

	Max.	16 kg
	Max.	1400 mm
	Max.	1000 mm
		16-19 mm



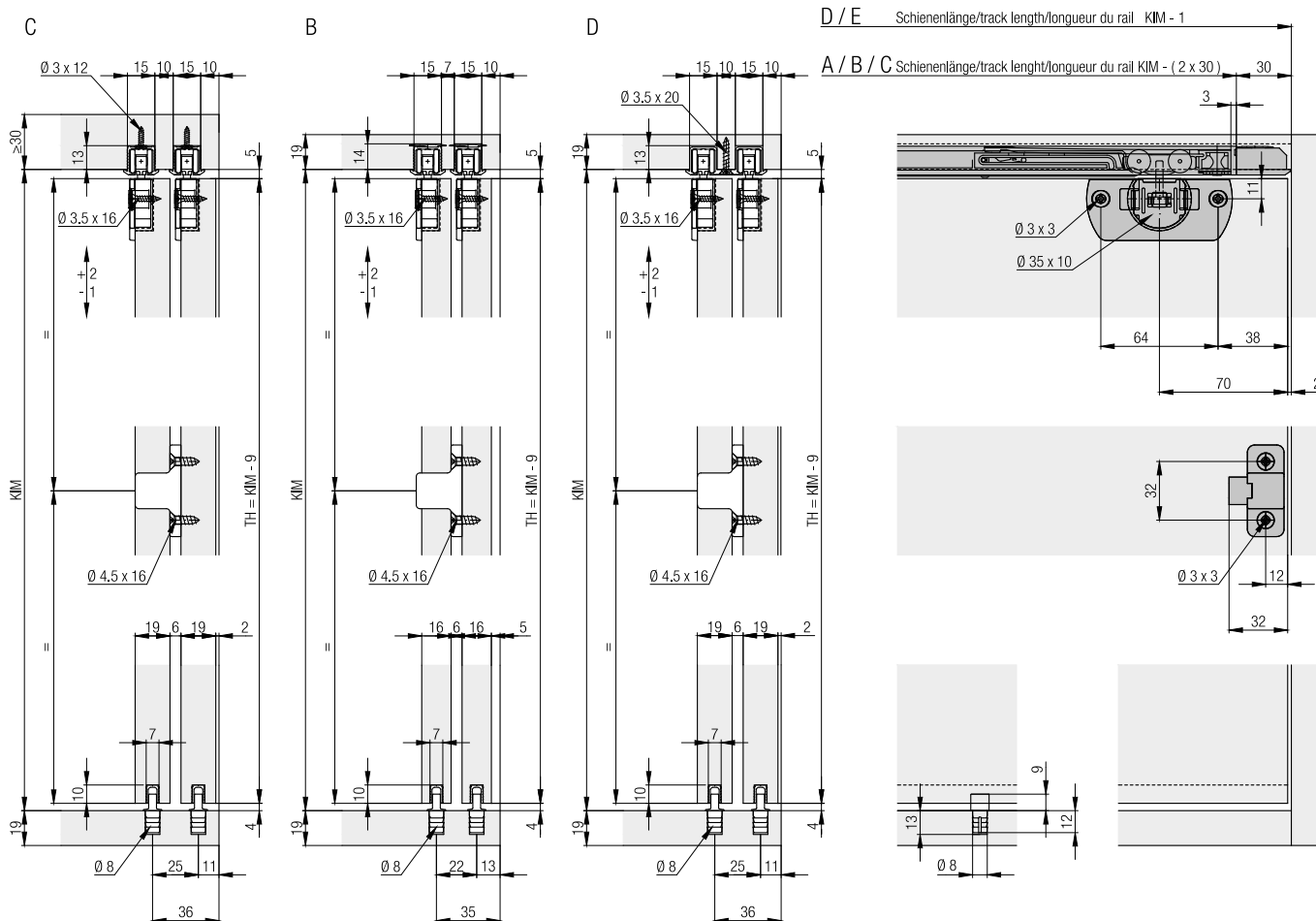

### Exemples de montage



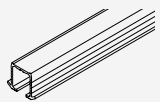
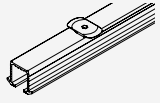
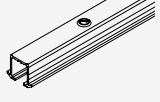
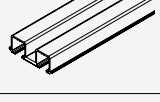

**Garniture pour 2 portes en bois jusqu'à 16 kg, avec réglage en hauteur**

		N°.	
Hawa Clipo 16 H IS, pour 2 portes		053.3220.071	
		053.3220.071	N°.
<b>Garniture composée de :</b>			
	Chariot Hawa Clipo 16 H/ Hawa Regal 16 C, plastique, anthracite	4	053.3205.071
	Butée Hawa Clipo 16/Hawa Regal 16 C, plastique, gris	2	053.3215.071
	Boîtier, plastique, anthracite	4	053.0183.001
	Vis à tête ronde, 3.5x16 mm, acier, zingué	8	766.6052.100
	Entraîneur de porte, plastique, anthracite	1	053.3217.071
	Vis à tête fraisée pour panneaux d'agglomérés, 4.5x16 mm, acier, zingué	2	600.0000.478
	Guidage de fond inférieur Hawa Clipo 16 H, plastique, anthracite	2	053.3214.001

**Rails de roulement**

		mm	N°.
	A: Rail de roulement simple, à coller, aluminium	2'500	053.3229.250
		3'500	053.3229.350
		6'000	053.3229.600
	B: Rail de roulement simple, avec verrou, aluminium (pas pour bois dur/MDF)	2'500	053.3227.250
		3'500	053.3227.350
		6'000	053.3227.600
	C: Rail de roulement simple, aluminium, percé	2'500	053.3225.250
		3'500	053.3225.350
		6'000	053.3225.600
	D: Rail de roulement double, aluminium, percé	2'500	053.3226.250
		3'500	053.3226.350
		6'000	053.3226.600
	E: Rail de roulement double, aluminium, anodisé	2'500	053.3231.250
		3'500	053.3231.350
		6'000	053.3231.600

**Kit de pièces d'extrémité du rail pour rails de roulement simple**

		N°.	
Pièce d'extrémité du rail, à visser, plastique, gris		053.3210.081	
Pièce d'extrémité du rail, avec verrou, plastique, gris		053.3211.081	
		053.3210.081	053.3211.081
		N°.	
<b>Garniture composée de :</b>			
	Pièce d'extrémité, à visser, plastique, gris	2	053.3210.001
	Pièce d'extrémité, avec verrou, plastique, gris	2	053.3211.071

**Rails de guidage**

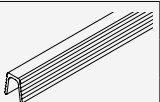
		mm	N°.
	Rail de guidage, largeur de rainure 7 mm, plastique, anthracite	2'500	053.3012.250
		3'500	053.3012.350
		6'000	053.3012.600

**Amortissement jusqu'à 8/16 kg**



		N°.
Amortissement Hawa Clipo 16/Hawa Regal C 16, jusqu'à 8 kg		053.3332.071
Amortissement Hawa Clipo 16 /Hawa Regal C 16, jusqu'à 16 kg		053.3332.072

		053.3332.071	053.3332.072	N°.
<b>Garniture composée de :</b>				
	Amortisseur, jusqu'à 8 kg	2		053.3330.071
	Déclencheur, avec butée	2	2	053.3331.071
	Vis à tête cylindrique bombée, 2.2x8 mm, acier, zingué	2	2	600.0000.482
	Amortisseur, jusqu'à 16 kg		2	053.3330.072

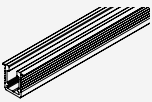
**Rails de guidage à 4 points**



		mm	N°.
	Rail de guidage simple, à coller, aluminium, anodisé	6'000	053.3296.600

**Pièces détachées guidage à 4 points**



		N°.
	Guidage de fond inférieur Hawa Clipo IS/Hawa Regal C 16, plastique, anthracite	040.3124.071
	Butée rail de guidage, plastique, gris	053.5094.071

**Centrage de porte**

		N°.
Centrage de porte, plastique, anthracite, pour 2 portes		053.3207.071

		053.3207.071	N°.
<b>Garniture composée de :</b>			
	Boîtier centrage, plastique, anthracite	2	053.5014.001
	Bouchon centrage, plastique, anthracite	2	053.0171.001
	Butée en caoutchouc, plastique, gris	1	025.0107.001

**Accessoires**

		N°.
	Boîtier Hawa Clipo 16, à presser, plastique, anthracite	083.3009.002
	Nettoyant pour rails, plastique, rouge	040.3142.071

**Autres exemples de montage**

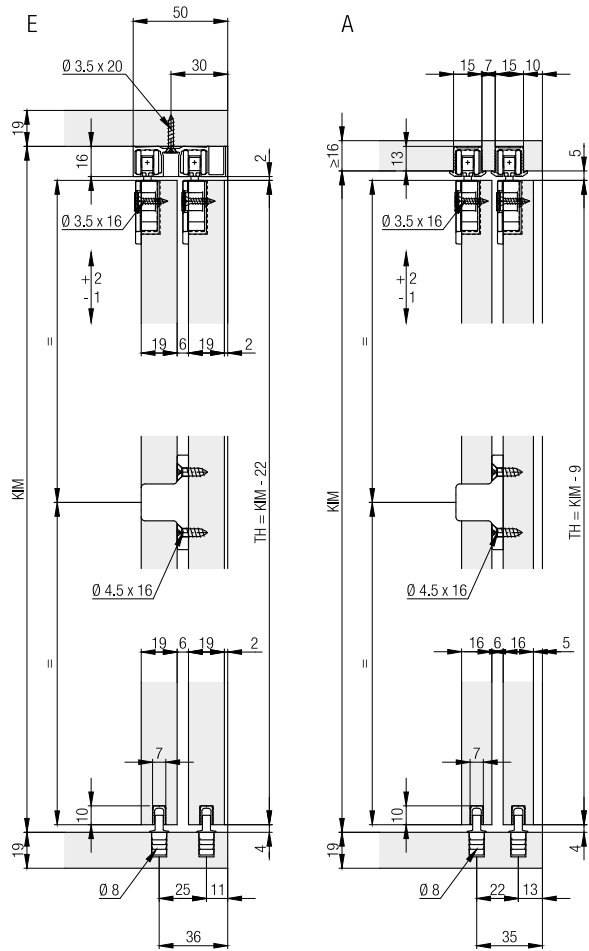

**Calculs**

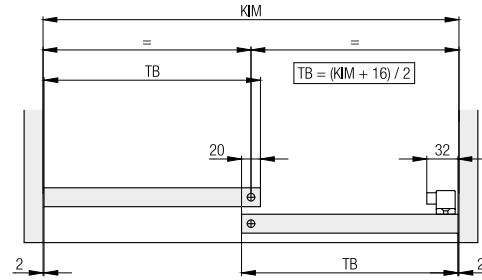

**Guidage à 4 points**

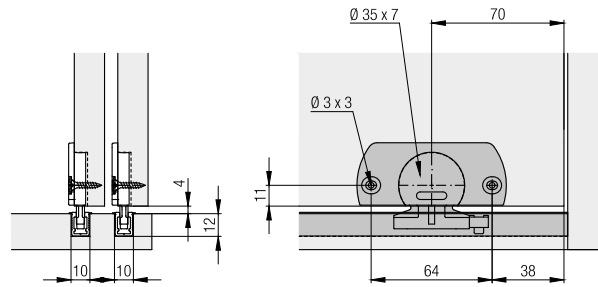

**Boîtier à enfoncer**

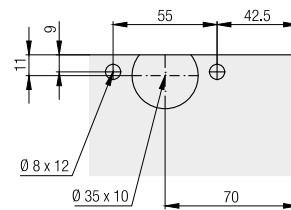

**Centrage de porte**

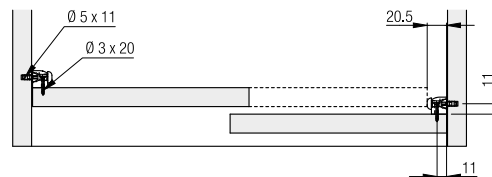

**Amortissement**

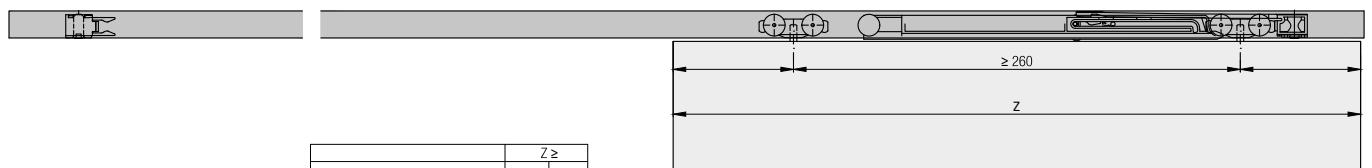

	Z ≥	
	1	2
Hawa Clipo 16 H IS	400	600
Hawa Clipo 16 H MS	438	638
Hawa Clipo 16 H FS	438	638
Hawa Clipo 16 HM IS	400	600
Hawa Clipo 16 GK IS	400	600
Hawa Clipo 16 GS IS	400	600
Hawa Clipo 16 GPK IS	400	600
Hawa Clipo 16 GPPK IS	400	600



**Accessoires**

– Ferrure de redressement à partir de la page 259

**Planification/exécution**

Plus d'informations sur le produit sont disponibles sur [www.hawa.com](http://www.hawa.com).