

## Ferrure pour 2 ou 4 portes en bois à roulement synchrone jusqu'à 40 kg en forme de L. Design Forslide.

### Produits phares



#### Confort

Grand confort d'utilisation grâce à une technique de roulement éprouvée et une technique d'amortissement intégré dans le système



#### Esthétique

Portes à roulement synchrone en forme de L pour une conception d'armoire unique avec double accès à l'armoire

### Spécifications techniques



Max. 40 kg



Max. 1500 mm



Max. 800 mm



19 mm

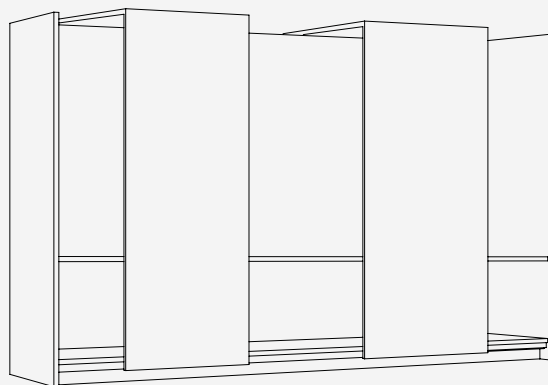

### Exemples de montage

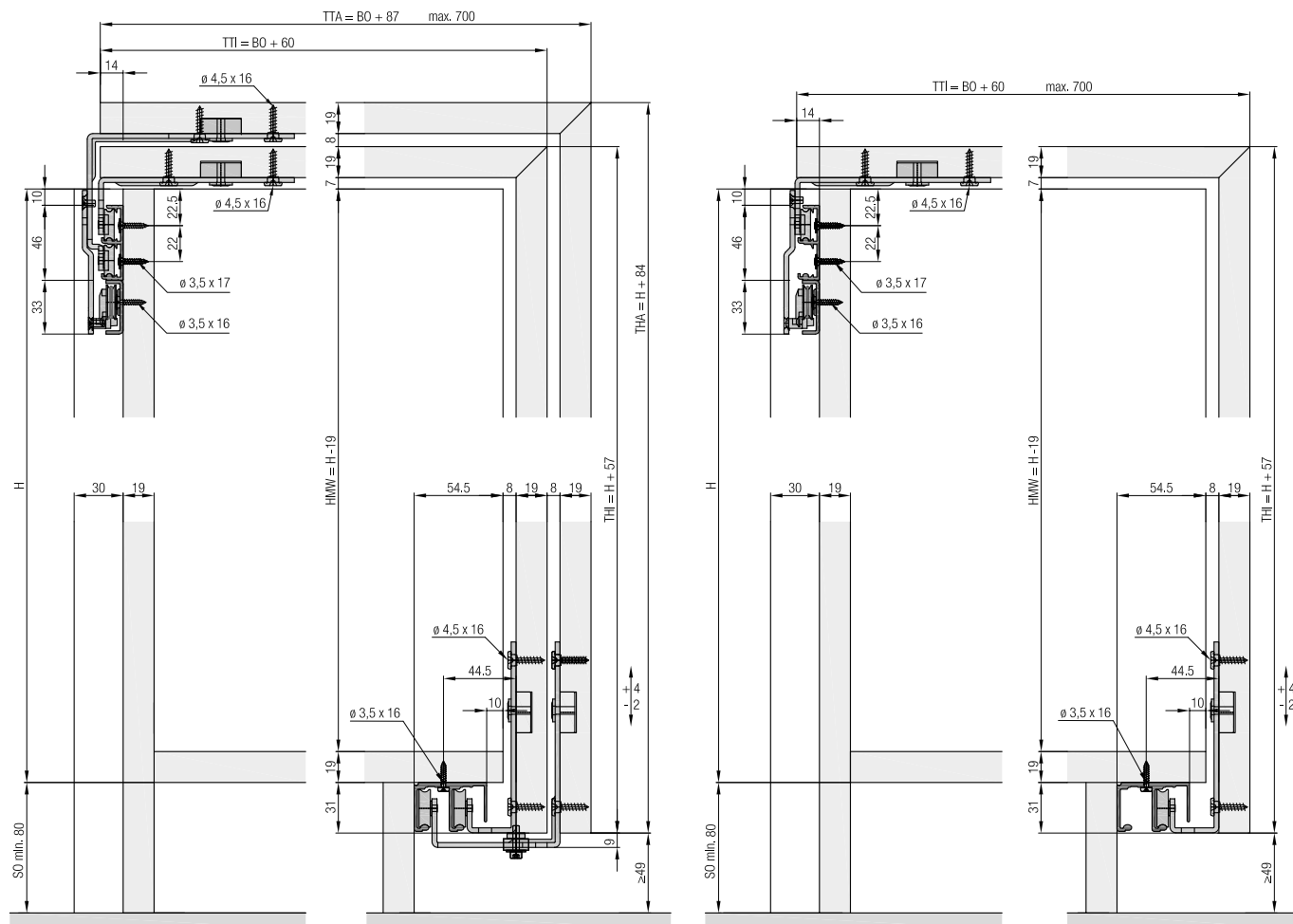

D'en haut/2 portes en bois

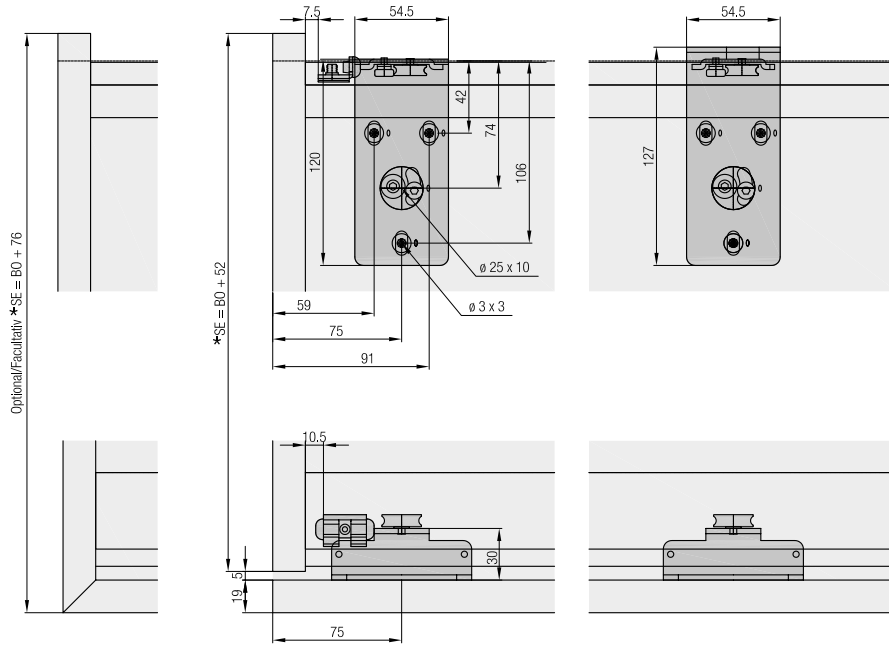

De devant/2 portes en bois

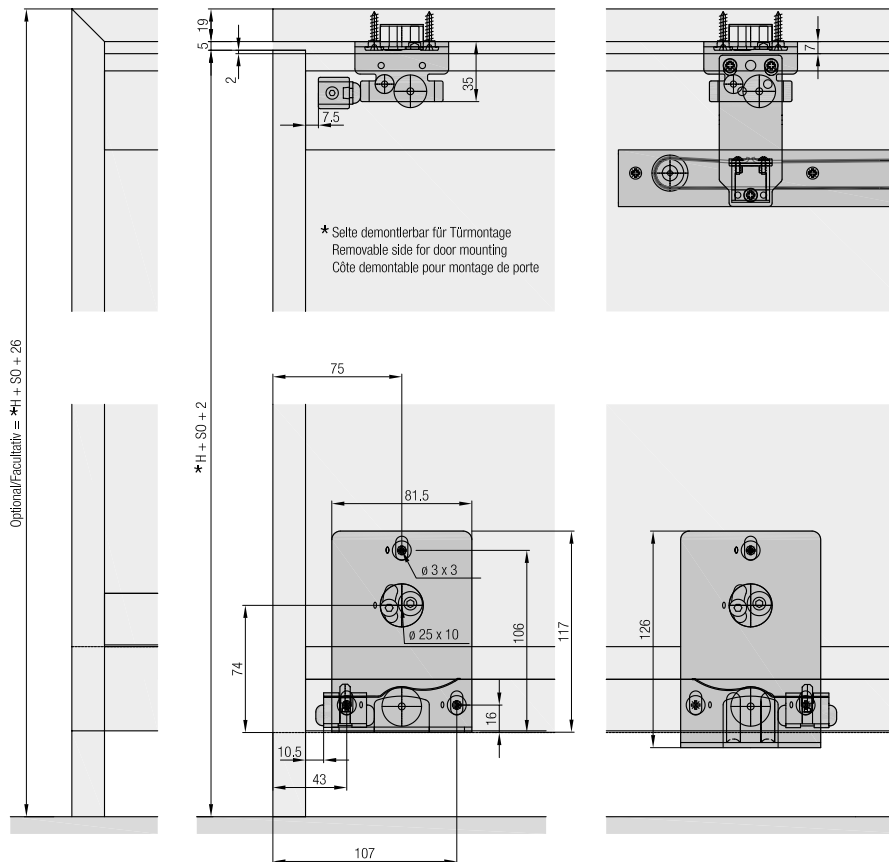

D'en haut/4 portes en bois

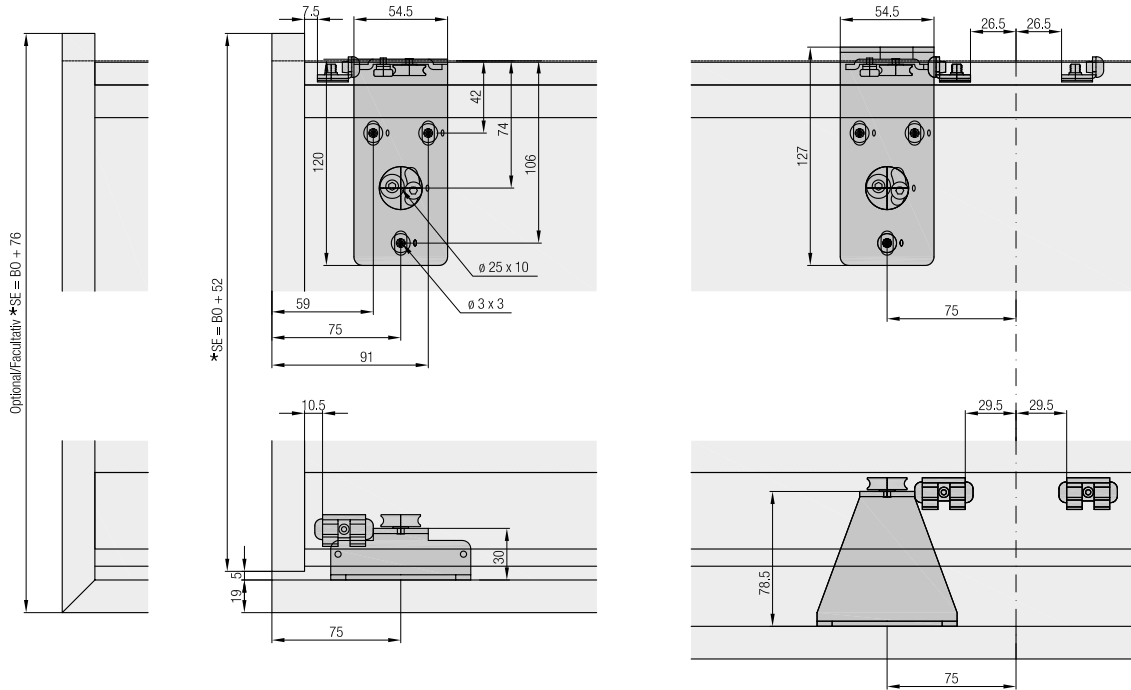



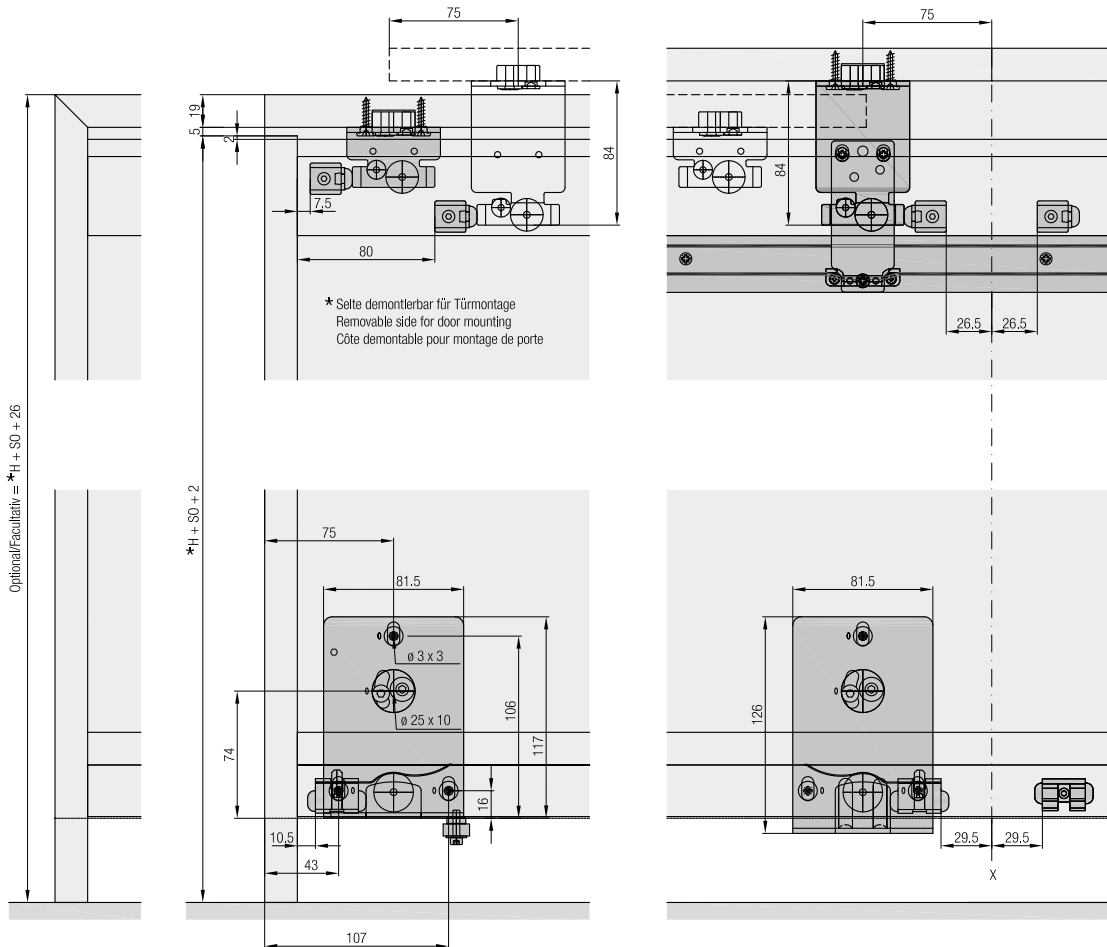



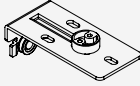

De devant/4 portes en bois





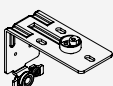

**Garniture pour 1 ou 2 portes en bois**  
**Commander toujours 2 garnitures.**

	N°.
Hawa Combino L 40 H FS, pour 1 porte en bois	056.3160.071
Hawa Combino L 40 H FS, pour 2 portes en bois	056.3160.072

Garniture composée de :		056.3160.071	056.3160.072	N°.
	Chariot, porte intérieure, acier, zingué	2	2	056.3155.171
	Équerre de guidage, porte intérieure, acier, zingué	2	2	056.3157.171
	Butée, plastique, gris	2	4	056.3151.071
	Ressort d'arrêt, acier	2	2	056.0174.001
	Butée, acier, zingué	2	4	056.3150.171
	Vis combi, 4,5x17 mm, acier, zingué	12	24	055.0100.101
	Vis à bois, 3,5x17 mm, acier, zingué	16	16	766.6052.100
	Chariot, porte extérieure, acier, zingué		2	056.3154.171
	Équerre de guidage, porte extérieure, acier, zingué		2	056.3156.171
	Entraîneur de porte, avec 2-3 portes		1	056.3162.171

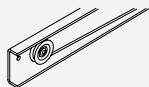
**Garniture Synchro**

	N°.
Hawa Combino L 40 H FS Synchro	056.3173.071

Garniture composée de :		056.3173.071	N°.
	Rail Symmetric, aluminium	1	040.5044.171
	Adaptateur, pour rail Symmetric, acier, zingué	2	056.0189.101
	Vis pour panneau d'aggloméré, 3,5x16 mm, acier, zingué	8	766.6035.116
	Vis à tête fraisée autotarandeuse, M4x8, acier, zingué	4	762.7007.108
	Vis à tête fraisée, M4x10 mm, acier, zingué	2	762.5003.100

**Rails de roulement**

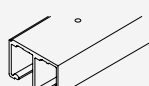
	mm	N°.
	2500	056.3149.250
	3500	056.3149.350
	6000	056.3149.600

**Rails de guidage**

	mm	N°.
	2500	056.3148.250
	3500	056.3148.350
	6000	056.3148.600

**Calculus**

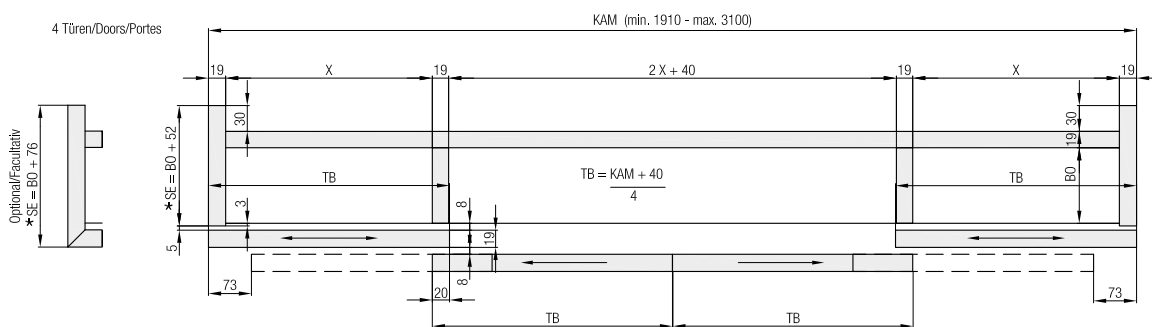
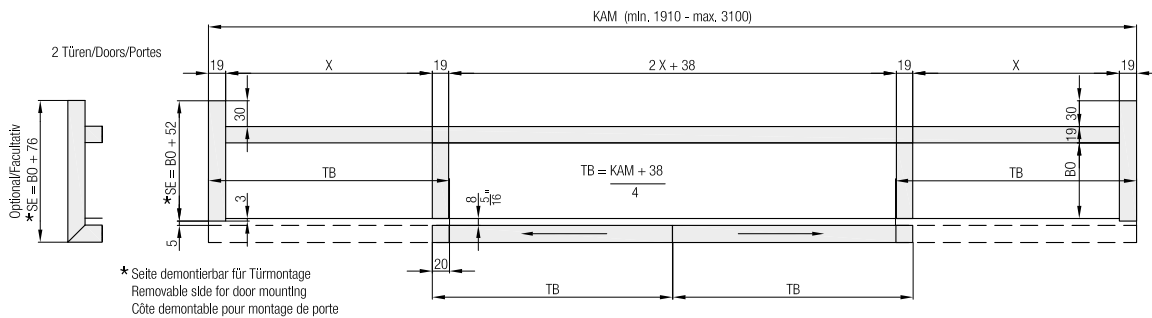

**Accessoires**

– Ferrure de redressement à partir de la page 317

**Planification/exécution**

Plus d'informations sur le produit sont disponibles sur [www.hawa.com](http://www.hawa.com).