

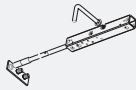

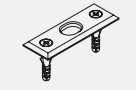

Hawa Doorfix

Pour fermeture, guidage et fixation des portes coulissantes, cloisons de séparation de pièces, parois pliantes et accordéon

| | | N°. |
|---|---|-------|
|  | Serrure à tringle, complète, acier, zingué | 15077 |
|  | Gâche, acier, chromé | 13130 |
|  | Douille de sol avec trou oblong et couvercle à ressort en laiton chromé | 13787 |
|  | Rosace pour douille de sol | 17326 |

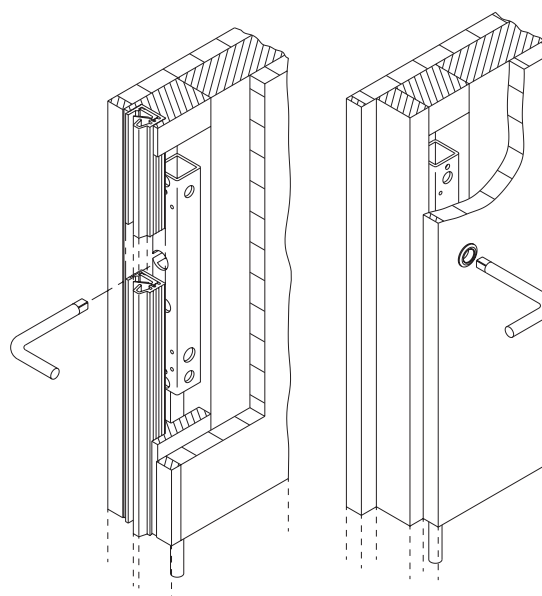



Rails de guidage

| | | mm | N°. |
|--|--|------------|-------|
|  | Rail de guidage laiton, percé 20x28x3 mm | 6'000 | 10245 |
| | | sur mesure | 10247 |

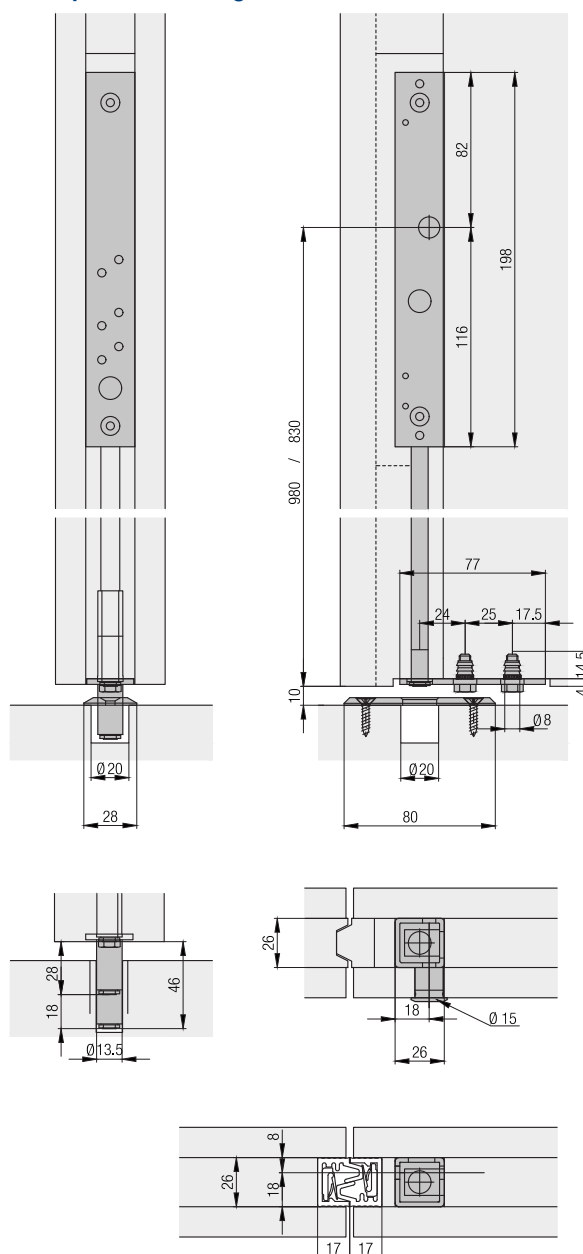
Exemples de montage

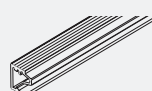

Profils d'étanchéité et profils en caoutchouc

| | | mm | N°. |
|---|---|------------|-------|
|  | Profil de centrage, anodisé couleur argent, percé | 6'000 | 14223 |
| | Profil d'étanchéité, aluminium, anodisé, percé | sur mesure | 13528 |
|  | Profil en caoutchouc, noir | 20'000 | 15340 |
| | | sur mesure | 13571 |

Exemples d'application

