

DE Vorderansicht  
FR Vue de face  
EN Front view  
IT Vista frontale  
ES Vista frontal

DE Ablängen der Profile  
FR Raccourcir les profils  
EN Cutting the profiles to length  
IT Taglio a misura dei profili  
ES Cortar a medida los perfiles

DE Seitenansicht  
FR Vue de côté  
EN Side view  
IT Vista laterale  
ES Vista lateral

DE Draufsicht  
FR Vue de dessus  
EN Top view  
IT Vista dall'alto  
ES Vista superior

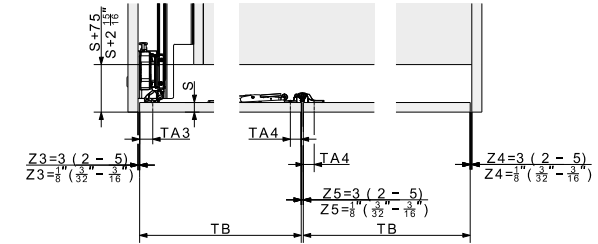
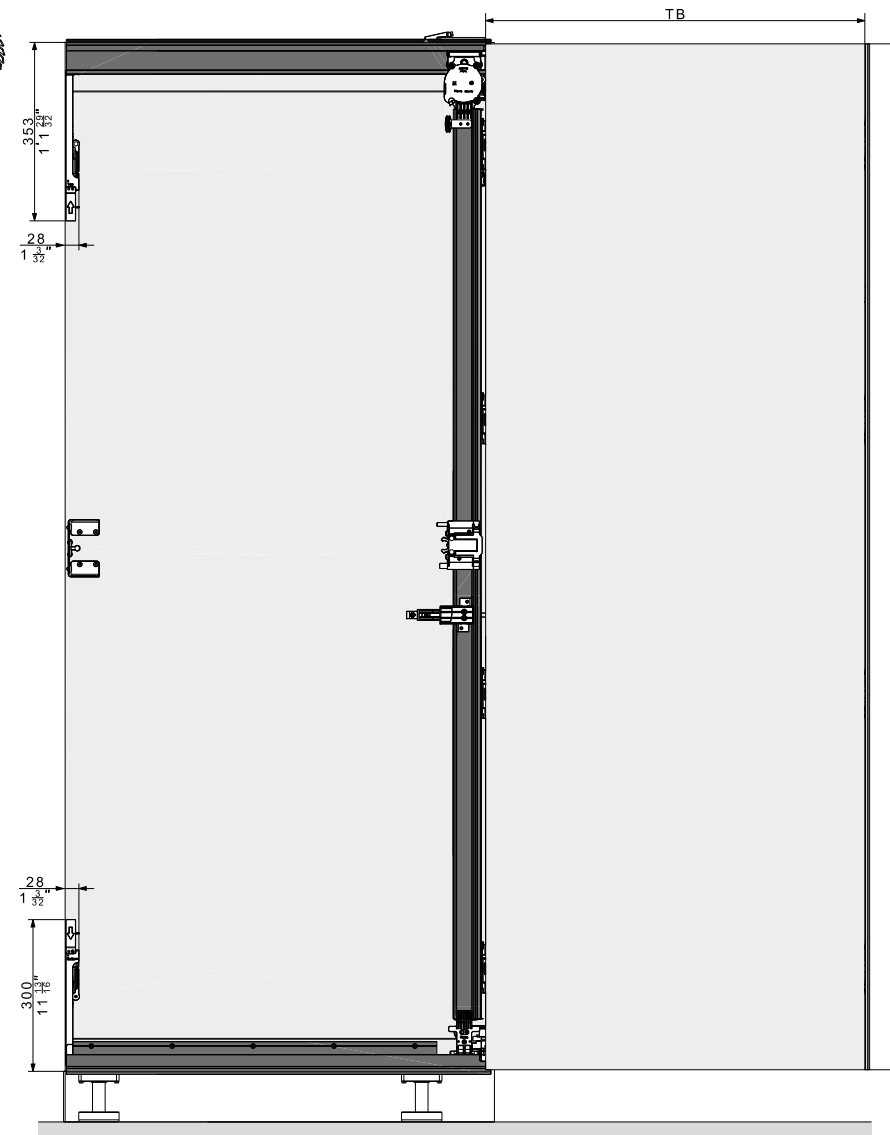
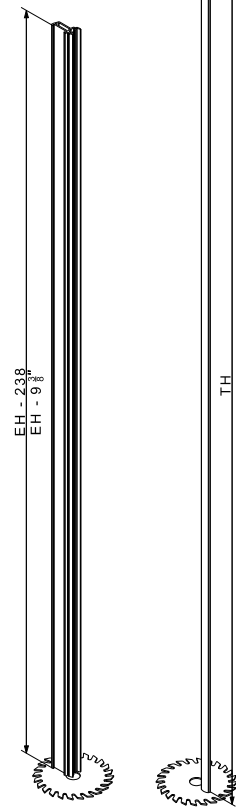
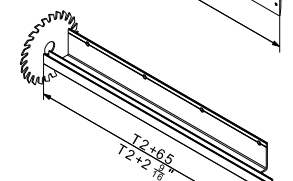
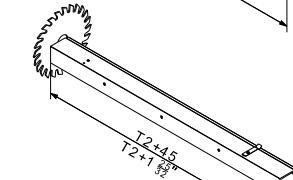
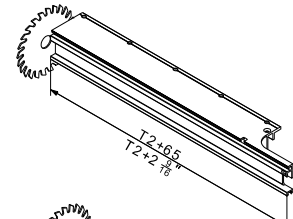
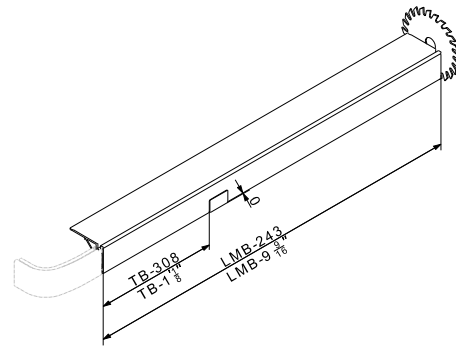
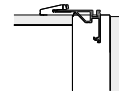
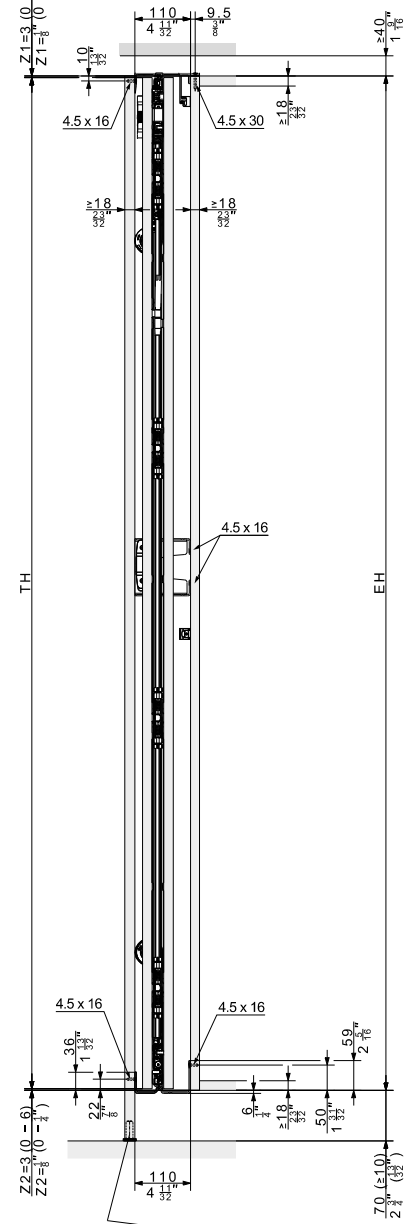

Z3	TA3	Z5	TA4
2 mm (3/32")	29 mm (1 1/8")	2 mm (3/32")	22.5 mm (7/8")
3 mm (1/8")	28 mm (1 1/8")	3 mm (1/8")	22 mm (7/8")
4 mm (5/32")	27 mm (1 1/8")	4 mm (5/32")	21.5 mm (7/8")
5 mm (3/16")	26 mm (1 1/8")	5 mm (3/16")	21 mm (7/8")

DE Türe vorstehend  
FR Porte en saillie  
EN Protruding door  
IT Porta sporgente  
ES Puerta saliente

DE Türe bündig  
FR Porte affleurante  
EN Flush door  
IT Porta complanare  
ES Puerta enrasada

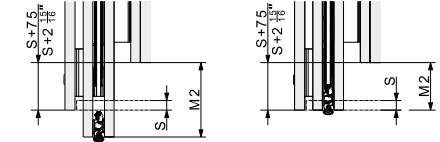

DE ohne Möbelboden  
FR Sans fond  
EN without base panel  
IT senza fondo del mobile  
ES sin base



DE mit Bodenprofil, siehe Beipackblatt 52036  
FR Avec profil de fond inférieur, voir le mode d'emploi joint 52036  
EN with base profile, see leaflet 52036  
IT con profilo a pavimento, vedere manuale di istruzioni 52036  
ES con perfil para la base: ver hoja de instrucciones 52036

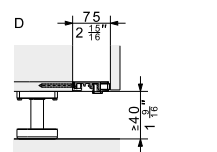

DE Empfehlung: Stellfuss verwenden  
FR Recommandation : utiliser un pied de réglage  
EN Recommendation: Use adjustable foot  
IT Raccomandazione: Utilizzare un piedino regolabile  
ES Recomendación: Utilizar un pie ajustable

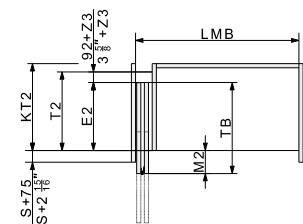
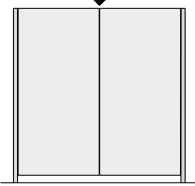

	mm	Inch
T2	TB + 92 + Z3 - M2	TB + 3 5/8" + Z3 - M2
E2	TB - M2	TB - M2
KT2	≥ T2	≥ T2
M2	≥ S + 2 ≤ TB - 390	≥ S + 2 11/16" ≤ TB - 1' 3 11/32"

	mm	Inch
S	18 - 26	23/32" - 1 1/32"
T2	≥ 344	≥ 1' 1 3/32"
TB	440 - 750	1' 5 5/16" - 2' 5 17/32"
TH (III 20)	1200 - 2200	3' 11 1/4" - 7' 2 5/8"
TH (III 25)	1900 - 2700	6' 2 13/16" - 8' 10 5/16"
Z1	0 - 6	0 - 1/4"
Z2	0 - 6	0 - 1/4"
Z3	2 - 5	3/32" - 3/16"
Z4	2 - 5	3/32" - 3/16"
Z5	2 - 5	3/32" - 3/16"

DE Abkürzungen / FR Abréviations / EN Abbreviations / IT Abbreviazioni / ES Abreviaturas

DE	FR	EN	IT	ES	
E2	Profondeur d'escamotage	Slide-in depth	Profondità di inserimento	Profundidad de introducción	
EH	Einbauhöhe	Installation height	Altezza d'incasso	Altura de montaje	
KT2	Korpusstiefe	Cabinet depth	Profondità mobile	Profundidad del mueble	
LMB	Lichtmassbreite	Inside clearance	Larghezza luce	Ancho interior	
M2	Türüberstand über Korpus	Saillie de la porte par rapport au corps	Door projection over cabinet	Sporgenza anta sopra il mobile	Solape de la puerta sobre el cuerpo
S	Türdicke	Spessore anta	Door thickness	Grosor de la puerta	
T2	Beschlagtiefe	Profondeur de ferrure	Hardware depth	Profondità ferramenta	Profundidad del herraje
TA	Topfachsabstand	Ecartement d'axe de la charnière invisible	Axis-centre distance of concealed hinge	Distanza scatola asse	Distanza de la cazoleta
TB	Türbreite	Largueur de porte	Door width	Larghezza anta	Ancho de puerta
TH	Türhöhe	Hauteur de porte	Door height	Altezza anta	Altura de puerta
Z	Luftzwischenraum	Jeu dans l'espace	Air gap	Traferro d'aria	Espacio libre

DE Hawa Folding Concepta III Push 2-türig links  
FR Hawa Folding Concepta III Push 2 portes, à gauche  
EN Hawa Folding Concepta III Push 2 doors, left  
IT Hawa Folding Concepta III Push 2 ante, a sinistra  
ES Hawa Folding Concepta III Push 2 puertas izquierda

DE Aussenseite A  
FR Face extérieure A  
EN Outer face A  
IT Lato esterno A  
ES Lateral exterior A

DE Beschlagsseite B  
FR Côte de la ferrure B  
EN Fitting side B  
IT Lato ferramenta B  
ES Lado del herraje B

DE Falttüre Folding Concepta III 25 Push  
FR Porte pliante Folding Concepta III 25 Push  
EN Folding Concepta III 25 Push folding door  
IT Porta a libro Folding Concepta III 25 Push  
ES Puerta plegable Folding Concepta III 25 Push

DE Falttüre Folding Concepta III 20 Push  
FR Porte pliante Folding Concepta III 20 Push  
EN Folding Concepta III 20 Push folding door  
IT Porta a libro Folding Concepta III 20 Push  
ES Puerta plegable Folding Concepta III 20 Push

DE Drehtüre Folding Concepta III 25 Push  
FR Porte tournante Folding Concepta III 25 Push  
EN Folding Concepta III 25 Push pivot door  
IT Porta girevole Folding Concepta III 25 Push  
ES Puerta giratoria Folding Concepta III 25 Push

DE Drehtüre Folding Concepta III 20 Push  
FR Porte tournante Folding Concepta III 20 Push  
EN Folding Concepta III 20 Push pivot door  
IT Porta girevole Folding Concepta III 20 Push  
ES Puerta giratoria Folding Concepta III 20 Push

DETAIL D 2:1 DE Siehe Beipackblatt 52124  
FR Voir le mode d'emploi joint 52124  
EN See leaflet 52124  
IT Vedere manuale di istruzioni 52124  
ES Ver hoja de instrucciones 52124

DETAIL H 2:1

DETAIL E 2:1

DETAIL F 2:1

DETAIL G 2:1

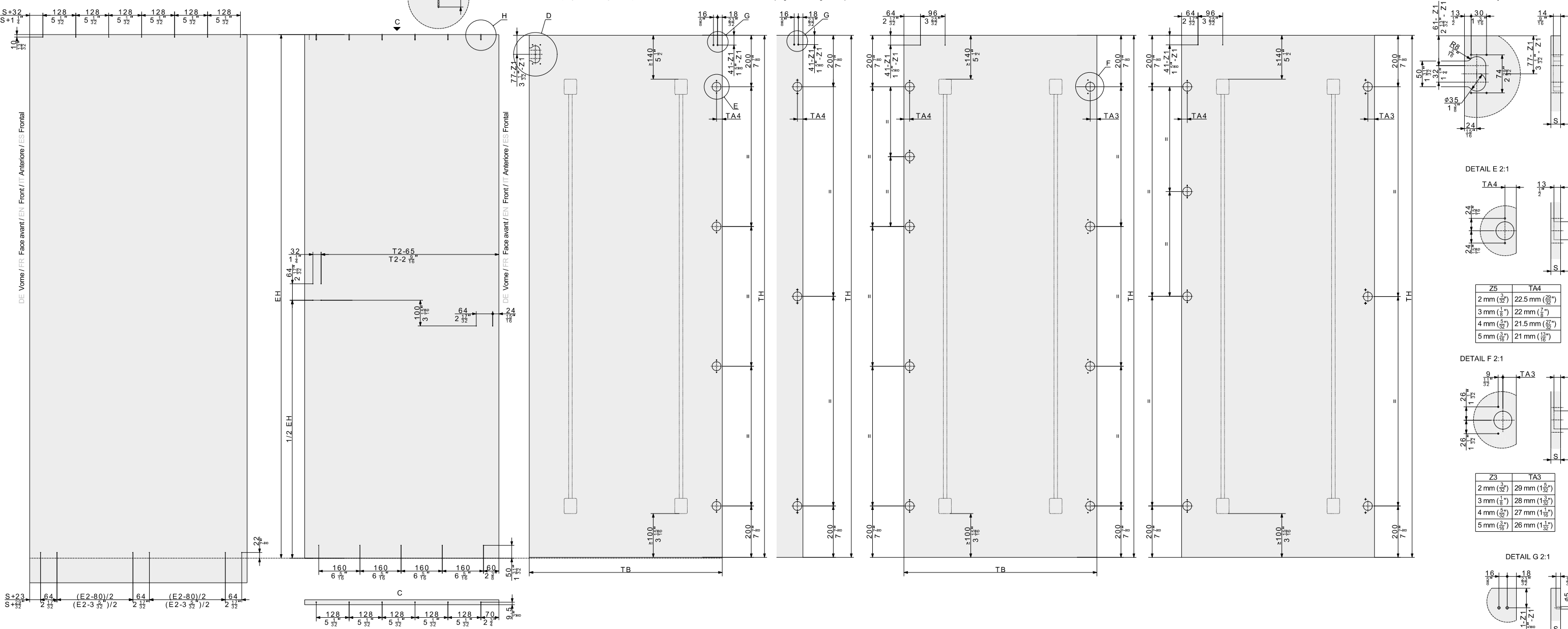

Z5	TA4
2 mm (3/32")	22.5 mm (7/8")
3 mm (1/8")	22 mm (7/8")
4 mm (3/16")	21.5 mm (5/8")
5 mm (3/16")	21 mm (13/16")

Z3	TA3
2 mm (3/32")	29 mm (1 1/8")
3 mm (1/8")	28 mm (1 3/8")
4 mm (3/16")	27 mm (1 1/8")
5 mm (3/16")	26 mm (1 1/8")

DE Schrankdeckel  
FR Couverture d'armoire  
EN Cabinet lid  
IT Copercchio del mobile  
ES Tapa del armario

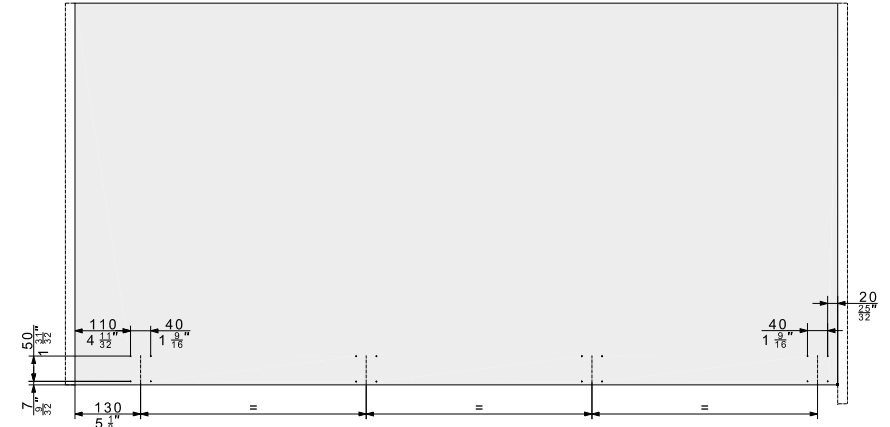

mm	Inch
T2	TB + 92 + Z3 - M2
E2	TB - M2
KT2	≥ T2
M2	≥ S + 2 15/16"
	≥ TB - 1' 3 11/32"

mm	Inch
S	18 - 26
T2	≥ 344
TB	440 - 750
TH (III 20)	1200 - 2200
TH (III 25)	1900 - 2700
Z1	0 - 6
Z2	0 - 6
Z3	2 - 5
Z4	2 - 5
Z5	2 - 5

DE Abkürzungen / FR Abréviations / EN Abbreviations / IT Abbreviazioni / ES Abreviaturas

DE	FR	EN	IT	ES
E2	Profondeur d'ancrage	Slide-in depth	Profondità di inserimento	Profundidad de introducción
EH	Hauteur d'ancrage	Installation height	Altezza d'incasso	Altura de montaje
KT2	Profondeur de corps	Cabinet depth	Profondità mobile	Profundidad del mueble
LMB	Largeur intérieure	Inside clearance	Larghezza luce	Ancho interior
M2	Türüberstand über Korpus	Saillie de la porte par rapport au corps	Door projection over cabinet	Solape de la puerta sobre el cuerpo
S	Türdicke	Epaisseur de porte	Door thickness	Grosor de la puerta
T2	Beschlagslänge	Profondeur de ferrure	Hardware depth	Profundidad del herraje
TA	Topfachsabstand	Ecartement d'axe de la charnière invisible	Axis-centre distance of concealed hinge	Distanza scatola asse
TB	Türbreite	Largeur de porte	Door width	Larghezza anta
TH	Türhöhe	Hauteur de porte	Door height	Altezza anta
Z	Luftzwischenraum	Jeu dans l'espace	Air gap	Traferro d'aria

DE Hawa Folding Concepta III Push 2-türig links  
FR Hawa Folding Concepta III Push 2 portes, à gauche  
EN Hawa Folding Concepta III Push 2 doors, left  
IT Hawa Folding Concepta III Push 2 ante, a sinistra  
ES Hawa Folding Concepta III Push 2 puertas izquierda

Hawa Folding Concepta III Push 2-türig links  
161985 V02 2/2

Gez./Verf.: 21.12.2023 BBU  
Rev./Verf.: 30.05.2024 SSI