

DE Montage der Unterlagen zu Schliesswinkel bei Festverglasung

FR Montage des cales sur la gâche équerre, pour un vitrage fixe

EN Assembling the lock bracket spacers for stationary glass

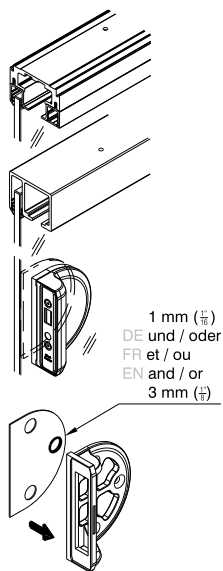
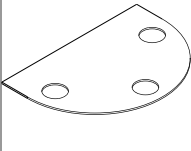
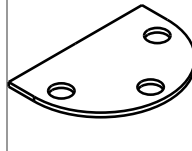
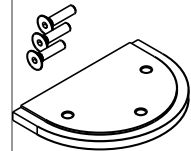
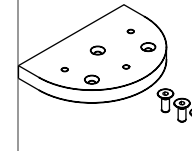

				
	1 mm ($\frac{1}{16}$ ")	3 mm ($\frac{1}{8}$ ")	20276 9 mm ($\frac{3}{8}$ ")	19622 12 mm ($\frac{15}{32}$ ")
Hawa Junior 40	✓	-	-	-
Hawa Junior 80	-	✓	-	-
Hawa Purolino Plus 80	-	-	-	✓
Hawa Puro 100-150	✓	✓	-	-
Hawa Junior 120	-	-	✓	-

DE Es gelten metrische Abmessungen – Abmessungen in Zollangaben sind nur zur Information.
EN Metric dimensions are valid – dimensions stated in inches are for information only.

Hawa Toplock

Patente Brevets Patents

DE Montage der Unterlagen zu Schliesswinkel bei Wandmontage

FR Montage des cales sur la gâche équerre, pour montage au mur

EN Assembling the lock bracket spacers for wall mounting

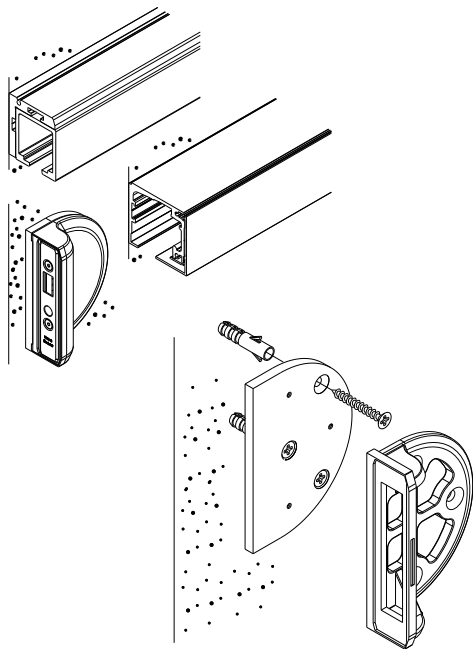

DE Gummi-Unterlagen werden nicht benötigt.

FR Les cales en caoutchouc ne sont pas nécessaires.

EN Rubber underlays are not required.

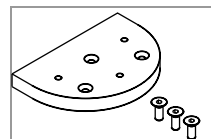

Hawa Junior 40	19621
Hawa Junior 80	17688
Hawa Puro 120	19622
Hawa Purofino Plus 80	17688